

TB108

Compact Excavator

Serial No. 10820001~

Book No. AB5E009

OPERATOR'S MANUAL



WARNING

Read and understand these instructions.
Failure to do so can cause injury or death.

TAKEUCHI





SAFETY ALERT SYMBOL

This symbol means Attention! Be Alert! Your Safety Is Involved. The message that follows the symbol contains important information about safety.

Read and understand the message to avoid personal injury or death.

- **It is the owner or employer's responsibility to fully instruct each operator in the proper and safe operation of all equipment. All persons using this machine should thoroughly familiarize themselves with the following sections.**
- **All operators must be instructed on the proper functions of the excavator before running the machine.**
- **Learn and practice correct use of the machine controls in a safe, clear area before operating this machine on a job site.**

 CAUTION	
 <small>EJAC0111</small>	<p>Improper operation, inspection and maintenance of this machine can cause injury or death.</p> <p>Read and understand this manual before performing any operation, inspection or maintenance on this machine.</p>



- **Always store this manual near at hand preferably on the machine itself. If it should be lost or damaged, immediately order a new one from your Takeuchi dealer. When transferring ownership of this machine, be sure to provide this manual to the next owner.**
- **Takeuchi supplies machines complying to the local regulations and standards of the country of export. If your machine has been purchased in another country or from a person or company of another country, it may not have the safety devices or safety standards required for use in your country. Should you have any question about whether your machine complies with the regulations and standards of your country, contact a Takeuchi dealer.**
- **Please note that the contents and diagrams included in this manual may not match your machine exactly.**

It is your responsibility to observe all pertinent laws and regulations and to follow the manufacturer's instructions on machine operation, inspection and maintenance.

Virtually all accidents occur as the result of a failure to observe basic safety rules and precautions. An accident can often be avoided by recognizing potentially hazardous situations beforehand. Read and understand all of the safety messages which explain how to prevent these accidents from occurring. Do not operate the machine until you are sure that you have gained a proper understanding of its operation, inspection and maintenance.

■ SIGNAL WORDS

Safety messages appearing in this manual and on machine decals are identified by the words "DANGER", "WARNING" and "CAUTION". These signal words mean the following:

 DANGER	 WARNING	 CAUTION
The word "DANGER" indicates an imminently hazardous situation which, if not avoided, can result in serious injury or death.	The word "WARNING" indicates a potentially hazardous situation which, if not avoided, could result in serious injury or death.	The word "CAUTION" indicates a potentially hazardous situation which, if not avoided, may result in minor or moderate injury.

IMPORTANT: The word "IMPORTANT" is used to alert against operators and maintenance personnel about situations which can result in possible damage to the machine and its components.

It is impossible to foresee every possible circumstance that might involve a potential hazard. The warnings in this manual or on the machine can not cover all possible contingencies. You must exercise all due care and follow normal safety procedures when operating the machine so as to ensure that no damage occurs to the machine, its operators or other persons.

■ EXPLANATION OF GRAPHICAL SYMBOLS

Following is an explanation of symbols used in this manual.

 / X prohibition

 Lock

 Unlock

INTRODUCTION

Foreword

This manual describes operation, inspection and maintenance of the machine, as well as safety instructions to be heeded during these operations.

If you have any questions about the machine, please contact a Takeuchi sales or service outlet.

■ Manual storage

A compartment for storing this manual is provided at the position shown on the diagram below.

After using the manual, place it in the plastic pouch and store it back in the manual storage compartment.

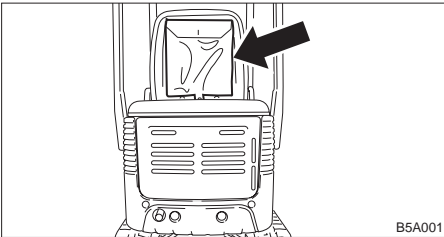

■ Serial numbers

Check the serial numbers of the machine and the engine and write them in the spaces provided below.

Machine number :

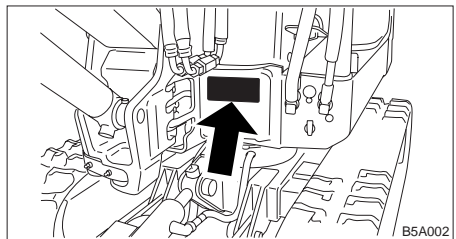

Engine number :

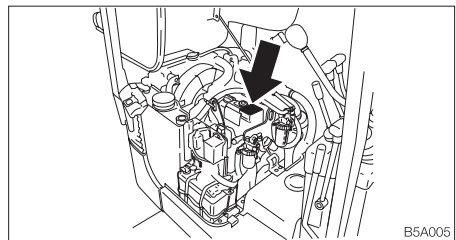

MACHINE DESCRIPTION

■ Front, rear, left and right

This manual refers the front, rear, left and right of the machine as seen when sitting in the operator's seat with the dozer blade visible to the front.

■ Designated operations

Use this machine primarily for the following operations:

- Excavating
- Digging ditches
- Digging side ditches
- Leveling
- Loading

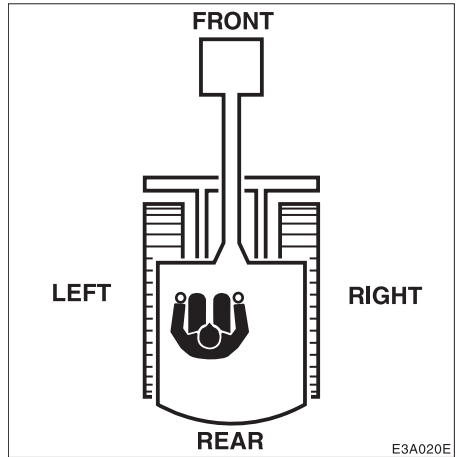

■ Features

- Short pitch rubber crawler
- Low engine noise and exhaust emissions
- Fast working speed and low-shock working equipment
- Excellent stability thanks to a low center of gravity









■ Break-in period

When is new, heed the instructions below when operating the machine for the first 100 hours (as indicated on the hour meter).

Using a new machine roughly without breaking it in will lead to quicker deterioration of machine performance and may shorten the machine's service life.

- Warm up the engine and hydraulic oil sufficiently.
- Avoid heavy loads and rapid operations. Operate with a load of about 80% the maximum load.
- Do not start up, accelerate, change directions, or stop abruptly unless necessary.

CONTENTS

Introduction	2
Machine Description	3
 Safety	7
 Controls	35
 Operation	51
 Transport	81
 Maintenance	85
 Troubleshooting	125
 Specifications	135
 Options	149
 Index	161



SAFETY

General precautions	8
Preparing precautions	12
Starting precautions	14
Operating precautions	16
Stopping precautions	23
Transporting precautions	24
Maintenance precautions	25
Safety signs (decals)	32

**Observe all safety rules**

- Operation, inspection and maintenance of this machine must be performed only by a trained and qualified person.
- All rules, regulations, precautions and safety procedures must be understood and followed when performing operation, inspection and maintenance of this machine.
- Do not perform any operation, inspection and maintenance of this machine when under the adverse influence of alcohol, drugs, medication, fatigue, or insufficient sleep.

Wear appropriate clothing and personal protective equipment

- Do not wear loose clothing or any accessory that can catch on controls or in moving parts.
- Do not wear oily or fuel stained clothing that can catch fire.
- Wear a hard hat, safety shoes, safety glasses, filter mask, heavy gloves, ear protection and other protective equipment as required by job conditions. Wear required appropriate equipment such as safety glasses and filter mask when using grinders, hammers or compressed air, as metal fragments or other objects can fly and cause serious injury.
- Use hearing protection when operating the machine. Loud prolonged noise can cause hearing impairments, even the total loss of hearing.

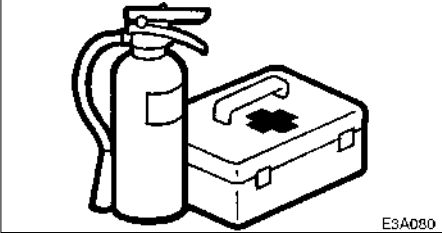
**Provide a fire extinguisher and first aid kit**

- Know where a fire extinguisher and first aid kit are located and understand how to use them.
- Know how to contact emergency assistance and first aid help.

Never remove safety equipment

- Make sure all protective guards, canopies, doors, etc., are in place and secure. Repair or replace damaged components before operating the machine.

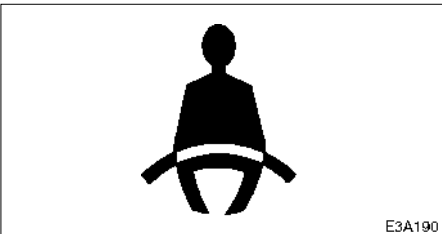

- Know how to use the safety lock lever, seat belt and other safety equipment and use them properly.
- Never remove any safety equipment except for service. Keep all safety equipment in good operating condition.

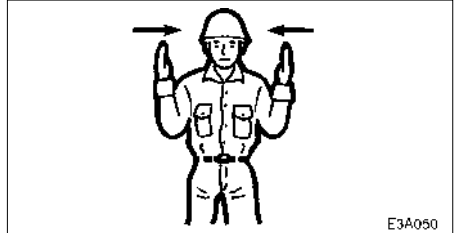
Use a signal person and flagman

Know and use the hand signals required for particular jobs and make sure who has the responsibility for signaling.

- All personnel must fully understand all the signals.
- The operator shall respond to signals only from the appointed signal person, but shall obey a stop signal at any time from anyone.
- The signal person must stand in a clearly visible location when giving signals.



Be sure to lock the safety lock lever before leaving the operator's seat

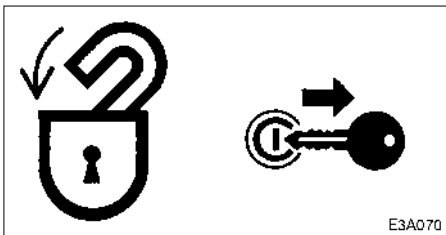

- Before leaving the operator's seat, raise the safety lock lever to engage the lock and stop the engine. If any controls should be touched accidentally when the safety lock lever is lowered, the machine will move suddenly, and cause serious injury or death.
- Note that the dozer blade, boom swing and auxiliary hydraulics controls are not locked, even when the safety lock lever is set to the lock position. Do not touch these controls accidentally.
- Before leaving the operator's seat, lower the working equipment, raise the safety lock lever, and stop the engine. Also, be sure to remove the key and take it with you.

Avoid fire and explosion hazards



Keep flames away from fuel, hydraulic fluid, oil, grease and antifreeze. Fuel is particularly flammable and dangerous.

- When handling these combustible materials, keep lit cigarettes, matches, lighters and other flames or sources of flames away.
- Do not smoke or permit open flames while fueling or near fueling operations.
- Never remove the fuel cap or refuel with the engine running or hot. Never allow fuel to spill on hot machine components.
- Clean up spilled fuel, oil or other flammable fluids immediately.
- Check for fuel, oil or hydraulic fluid leaks. Stop all leaks and clean the machine before operating.
- Do not cut or weld on pipes or tubes that contain flammable fluids. Clean thoroughly with nonflammable solvent before cutting or welding.
- Remove all trash or debris from the machine. Make sure that oily rags or other flammable material are not stored on the machine.
- Handle all solvents and dry chemicals according to procedures identified on manufacturers' containers. Work in a well-ventilated area.
- Never use fuel for cleaning purposes. Always use a nonflammable solvent.
- Store all flammable fluids and materials in a safe and well-ventilated place.

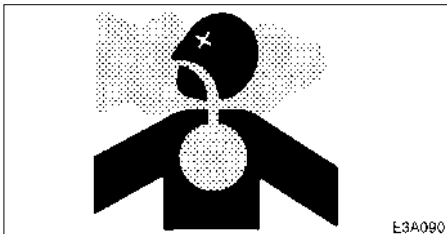
**Exhaust fumes from the engine can kill**

- Do not operate the engine in an enclosed area without adequate ventilation.
- If natural ventilation is poor, install ventilators, fans, exhaust extension pipes or other artificial venting devices.

Handling asbestos dust

Inhaling asbestos dust has been linked to lung cancer. When handling materials which may contain asbestos, take the following precautions:

- Never use compressed air for cleaning.
- Avoid brushing or grinding of the materials.
- For clean up, use wet methods or a vacuum equipped with a high efficiency particulate air (HEPA) filter.
- Wear an approved respirator if there is no other way to control the dust. When working indoors, install a ventilation system with a macro molecular filter.

Be careful not to get crushed or cut

Never put your hands, feet or other parts of your body between the upperstructure and the undercarriage or tracks, between the machine body and working equipment, or between a cylinder and moving part. The size of these gaps change when the machine moves and if caught a person can suffer severe injury or death.

Using optional products

- Consult with a Takeuchi dealer before installing optional attachments.
- Do not use attachments that have not been approved by Takeuchi or a Takeuchi dealer. Doing so may compromise safety or adversely affect the machine's operation or service life.
- Takeuchi will not be held responsible for any injuries, accidents or damage to its products caused by the use of a non-approved attachment.

Never modify the machine

Unauthorized modifications to this machine can cause injury or death. Never make unauthorized modifications to any part of this machine.

**Know the working area**

Before starting operation, know the working area to ensure safety.

- Check the topography and ground condition of the working area, or the structure of the building when working indoors, and take the necessary safety measures in dangerous spots.
- Note and avoid all hazards and obstructions such as ditches, underground lines, trees, cliffs, overhead electrical wires or areas where there is danger of a slide.

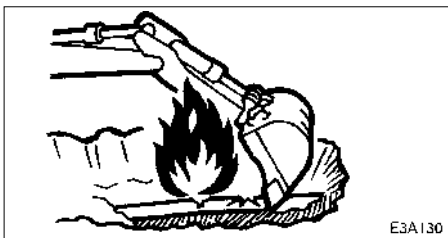

- Check with the local utilities for the locations of buried gas and water pipes and buried power cables. Determine jointly what specific precautions must be taken to insure safety.
- When working on roads, be sure to take into account the safety of pedestrians and vehicles.
 - Use a flagman and/or signals.
 - Fence off the working area and prohibit entry to unauthorized persons.
- When working in water or crossing shallow streams or creeks, check the depth of the water, the solidity of the ground, and the speed of the current beforehand. Make sure the water is not deeper than the allowable depth.

Refer to the section titled "Cautions on Operating" for further instructions.

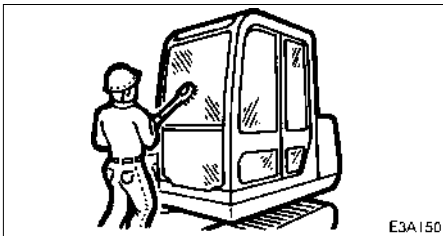
Always keep the machine clean

- Clean windows, mirrors and lights to ensure good visibility.
- Wipe off any oil, grease, mud, snow or ice, to prevent accidents due to slipping.
- Remove all loose objects stored in the machine and all objects which do not belong in or on the machine and its equipment.
- Remove any dirt, oil or grease from the engine area, to prevent fires.
- Clean the area around the operator's seat, removing any potential obstacles.



SAFETY

Preparing Precautions

Perform inspection and maintenance daily



E3A520

Failure to notice or repair machine irregularities or damage can lead to accidents.

- Before operating, perform the prescribed inspections and make repairs immediately should any irregularities be found.
- If a failure that causes loss of control such as steering, service brakes or engine occurs, stop the machine motion as quickly as possible, follow the shutdown procedure, and keep machine securely parked until the malfunction is corrected.

**Maintain three point contact when mounting and dismounting**

- Do not jump on or off the machine. Never attempt to mount or dismount a moving machine.
- When mounting and dismounting the cab, first open the door fully to the locked position and check that it does not move. (For machines with cabs)



- Always face the access system and maintain a three point contact with the recommended handrails and steps while getting on and off the machine. Keep steps and platform clean.
- Never use the safety lock lever or control levers as hand holds.

Clear the area of other persons before starting the machine

Do not start the engine until you are sure it is safe. Before starting, check or perform the following.

- Walk around the machine and warn all personnel who may be servicing the machine or are in the machine path. Do not start until all personnel are clearly away from the machine.
- Check for any “DO NOT OPERATE” tags or similar warning notices on the cab door, controls or starter switch.
- Sound horn to alert everyone around the machine.

Start the engine from the operator’s seat

- Adjust, secure and latch the operator’s seat.

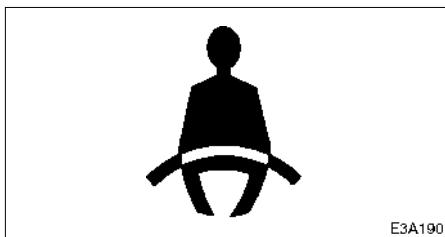

- Fasten the seat belt.
- Check that the parking device is applied and place all controls in the neutral position.
- Check that the safety lock lever is in the lock position.
- Clear the area of all persons.
- Start and operate the engine from the operator’s seat only.
- Never attempt to start the engine by shorting across the starter terminals.

**Starting with jumper cables**

Use jumper cables only in the recommended manner. Improper use of jumper cables can result in battery explosion or unexpected machine motion.

Refer to the section titled “If the Battery Goes Dead” for proper instructions.

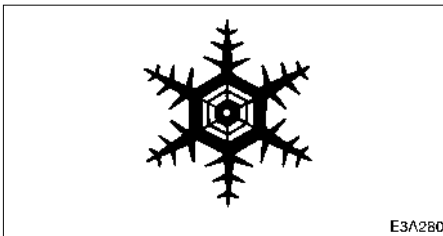
In cold weather

- Be careful of slippery conditions on freezing ground, steps and hand holds.
- In severe cold weather, do not touch any metal parts of the machine with exposed flesh, as flesh can freeze to the metal and Cause injury.
- Do not use ether or starting fluids on this engine. These starting aids can cause explosion and serious injury or death.
- Warm up the engine and hydraulic fluid before operating.

After starting the engine

After starting the engine, perform the following operations and checks in a safe place with no persons or obstacles in the area. If any malfunctions are found, follow the shutdown procedure and report the malfunction.

- Warm up the engine and hydraulic fluid.
- Observe all gauges or warning instruments for proper operation.
- Listen for unusual noises.
- Test engine speed control.
- Operate each control to insure proper operation.

**Ensure good visibility**

- When working in dark places, turn on the machine's working lights and headlights and/or provide extra stationary lighting if necessary.
- When visibility is poor due to severe weather (fog, snow or rain), stop operating the machine and wait until conditions improves.

Do not permit riders on the machine

- Do not allow anyone to ride on any part of the machine at any time while traveling.
- Do not allow anyone to be on any part of the machine while operating.

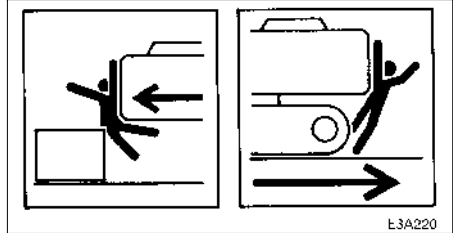
Check for safety in the surrounding area before starting

- Understand the machine limitations.
- Use a signal person where clearances are close or your vision is obstructed.
- Never allow anyone to enter the slewing (swing) radius and machine path.
- Signal your intention to move by sounding the horn.
- There are blind spots to the rear of the machine.

If necessary, swing the cab around before backing up to check that the area is safe and clear.



SAFETY

Operating Precautions

Check the position of the under-carriage (tracks) before traveling

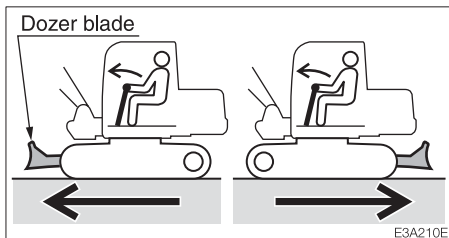

Before operating the travel levers, check to make sure that the dozer blade is to the front of the operator's seat. **BE AWARE** that when the dozer blade is to the rear of the operator's seat, the travel levers operate in the opposite direction to when the dozer blade is in the front.

Fully extend the crawler width when operating

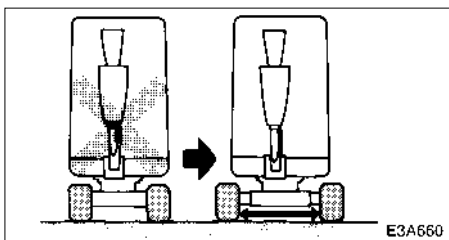

Always operate the machine with the crawler width at the maximum to increase machine stability. The smaller the crawler width, the greater the possibility the machine can tip over. If it is absolutely necessary to operate the machine with a narrow crawler width, do so with great care.

Travel safety

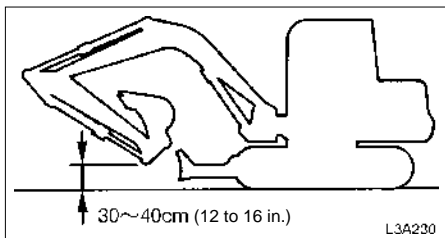

- Travel with the dozer blade up, the hoe attachment folded as shown on the diagram, and the bucket raised 30 to 40 cm (12 to 16 in.) from the ground.
- Do not slew (swing) while traveling. If you must operate the hoe attachment while traveling, operate at speeds slow enough so you have complete control at all times.

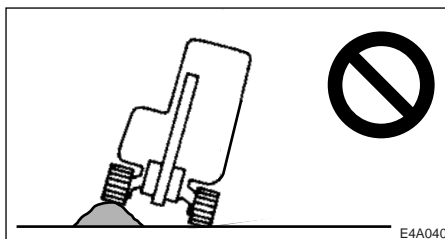

- Avoid crossing over obstacles whenever possible. If you must do so, keep the hoe attachment close to the ground and travel slowly. Never cross obstacles if they will seriously tilt the machine (to an angle of 10° or greater).
- On uneven ground, travel at low speed and avoid accelerating, stopping or changing directions abruptly.
- When roading a machine, know and use the signaling devices required on the machine. Provide an escort for road travel when required.



SAFETY

Operating Precautions

Cautions on traveling on slopes

When traveling on slopes or grades, be careful that the machine does not tip (roll) over or slide.

- Never exceed the machine's stability capabilities (maximum gradeability - 25°, lateral tipping angle - 10°). Also note that when actual working area conditions are poor the machine's stability capabilities may be lower.

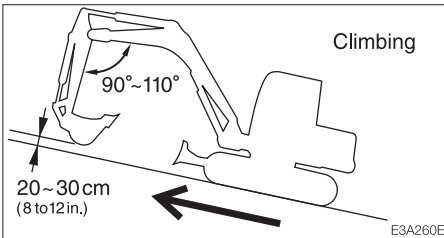
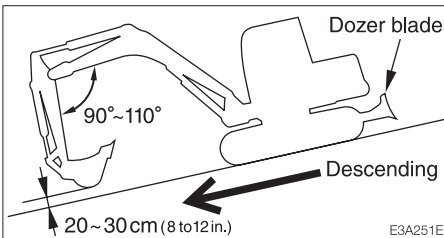

- When traveling on slopes or grades, lower the bucket to a height of 20 to 30 cm (8 to 12 in.) off the ground. In emergencies, lower the bucket to the ground and stop the machine.
- When traveling on slopes or grades, move slowly in first gear (low speed).
- Do not travel down slopes in reverse.
- On grass, dead leaves, wet metal or frozen surfaces, the machine may slide sideways even on very gentle slopes. Make sure the machine never faces sideways with respect to the slope.

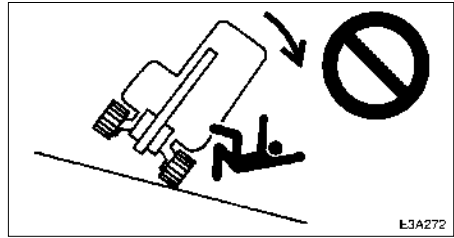

- Do not change directions or cross slopes sideways. First return to a flat surface then redirect the machine.

Operate on snow or ice with extra care

- When traveling on snow or frozen surfaces, keep the machine travel speed down and avoid accelerating, stopping or changing directions abruptly.
- Remember that the road shoulder, fences, etc., may be buried in the snow and not visible.
- Lower the dozer blade when parked on unsure ground conditions.

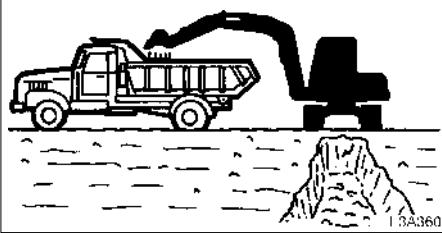
**Insure driver safety before loading trucks**

Do not load a truck unless the driver is in a safe place.

- Never swing or position the bucket over personnel or truck cabs.
- Load the truck from the rear.

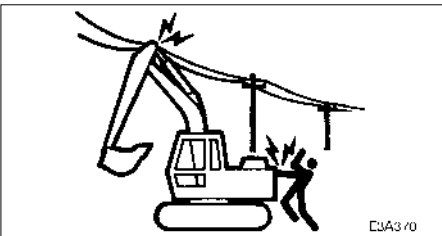
Keep a safe distance from electrical power lines

Never approach power lines with any part of the machine and its load unless all local and national required safety precautions have been taken. Electrocutation and death can result from arcing, touching or even being close to a machine that is in contact with or near an electrical source.

- Maintain the maximum possible distance from power lines and never violate the minimum clearance.
- Always contact the nearest electric utility and determine jointly what specific precautions must be taken to insure safety.
- Consider all lines to be power lines and treat all power lines as energized even though it is known or believed that the power is shut off and the line is visibly grounded.
- Use a signal person to observe the approach of any part of the machine or load to the power line.
- Caution all ground personnel to stand clear of the machine and the load at all times.
- If the machine should come in contact with a live electrical source, do not leave the operator's seat. Do not allow anyone to approach or touch the machine.

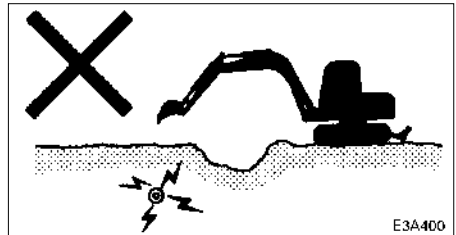

- Be especially careful of buried high voltage power lines.



Watch out for hazardous working conditions

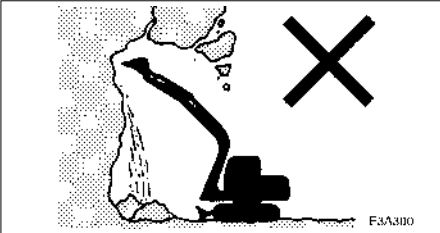

- Never undercut a high bank. Be particularly alert for the possibility of a cave-in.
- Do not operate in places where there is a danger of falling rocks.

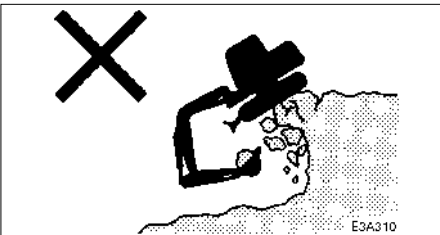

- Keep machine well back from the edge of an excavation. Avoid undercutting the machine.

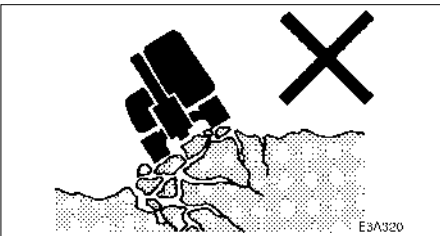

- Do not approach unstable surfaces (cliffs, road shoulders, deep trenches, etc.). The ground may give way under the machine's weight or vibrations, causing the machine to tip over.

- The ground is weak after rain or explosions.
- The ground is also unstable on banks and near dugout trenches.

Operating on slopes is dangerous

When operating on slopes or grades, slewing (swinging) or operating working equipment may cause the machine to lose stability and tip over. Avoid operating on slopes whenever possible.

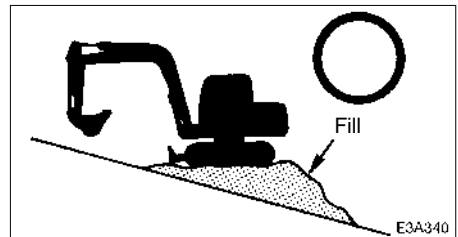

- Level off the work area.

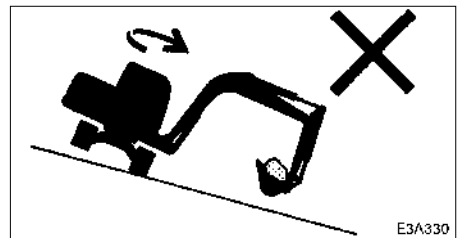

- Avoid swinging the loaded bucket in a downhill direction. This will reduce the stability of the machine.

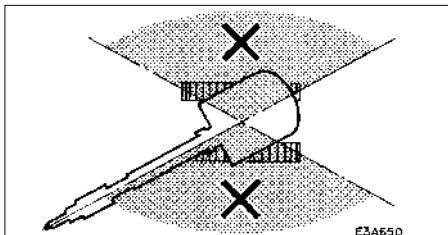
**Never slew (swing) sideways with excessive weights**

The machine can tip over more easily in the lateral direction than in the longitudinal direction.

- Do not slew (swing) sideways with excessive weight at the front. In particular do not slew sideways on slopes.
- The front is heavier for machines equipped with breakers, crushers or telescopic arms than for machines equipped with the standard bucket. Do not operate such machines sideways especially with the digging arm (boom) downhill.

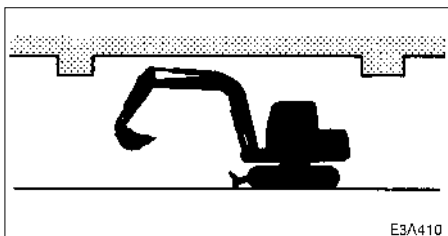
Watch boom clearance

When operating under bridges, in tunnels, near power lines or indoors, be careful not to hit the boom or arm against overhead objects.

Excavators are not designed for lifting loads

The machine is specifically designed for excavation work and has no safety devices for crane operation. Extreme caution should be used if the excavator is used for lifting.

- Never lift loads in excess of capacity. Overload will cause the machine to roll and can result in serious injury or death.
- All rated lift capacities are based on the machine being level and on a firm supporting surface. For safe working loads, the user is expected to make due allowance for the particular job conditions such as soft or uneven ground, non-level condition, side loads, dynamic or jerked loads, hazardous conditions, experience of personnel, etc. The operator and other personnel should fully acquaint themselves with the operator's manual before operating this machine, and rules for safe operation of equipment shall be adhered to at all times.
- Failure of the bucket linkage or slings could result if chains or slings are incorrectly attached, resulting in serious injury or death.
- Do not attempt to pull stumps out of the ground while using the machine as a crane. The loads imposed on the machine under this use are completely unknown.
- Never allow any personnel to stand on or under lifted loads or even within the maneuvering area.



Danger of flying objects

This machine is not equipped with protective guards to protect the operator from flying objects. Do not use the machine in places where there are risks of the operator being hit by flying objects.

Cautions on Towing

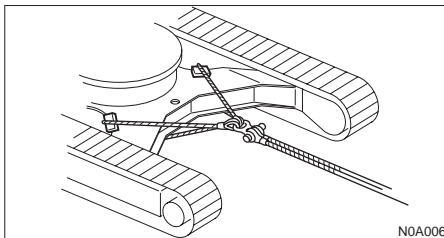

When towing, selecting the wrong wire rope, inspecting improperly, or towing in the wrong way could lead to accidents resulting in serious injury or death.

- The wire rope breaking or coming detached could be extremely dangerous. Use a wire rope suited for the required towing force.
- Do not use a wire rope that is kinked, twisted or otherwise damaged.
- Do not apply strong loads abruptly to the wire rope.
- Use safety gloves when handling the wire rope.
- Make sure there is an operator on the machine being towed as well as on the machine that is towing.
- Never tow on slopes.
- Do not let anyone near the wire rope while towing.

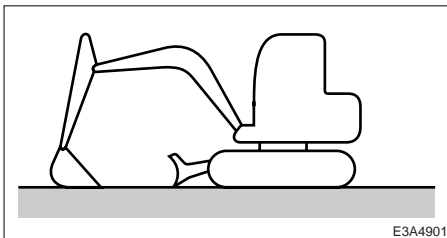
**Park safely**

- Park the machine on firm, level ground and apply the parking device.
- When parking on streets, use barriers, caution signs, lights, etc., so that the machine can easily be seen even at night to avoid collision with other vehicles.

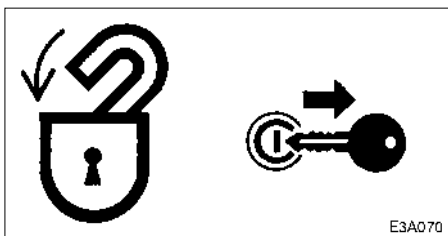

- Before leaving the machine, do the following:
 1. Set the slew lock lever to the locked position.
 2. Lower the bucket and dozer blade to the ground.
 3. Raise the safety lock lever to engage the lock.
 4. Stop the engine and remove the key.
 5. Lock the engine hood and the tool box (option).



Load and unload the machine safely

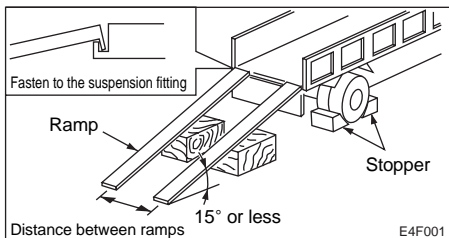

The machine may roll or tip over or fall while loading or unloading it. Take the following precautions:

- Select a firm, level surface and keep sufficient distance from road shoulders.
- Use loading ramps of adequate strength and size. Maintain the slope of loading ramps within 15 degrees.
- Secure the ramps to the truck bed.
- Keep the truck bed and loading ramps clean of oil, clay, ice, snow, and other materials which can become slippery. Clean the tracks.
- Block the transport vehicle so it can not move.
- Use a signal person when loading and unloading the machine, and travel slowly in first gear (low speed).
- Never change course on the ramp.
- Do not slew (swing) on ramps. The machine may tip over.
- When slewing (swinging) on the truck bed, do so slowly as the footing can be unstable.
- Engage the slew (swing) lock after loading.
- Block both tracks and secure the machine to the truck bed with load binders.

Lifting the machine safely

- Know and use correct crane signals.
 - Inspect the lifting equipment daily for damaged or missing parts.
 - Keep all other persons out of the area when lifting. Do not move the machine over the heads of their persons.
 - Do not lift the machine with an operator(s) on it.
 - When lifting, use a wire rope with sufficient strength with respect to the machine's weight.
 - Do not lift with the machine in a posture other than the one described in the procedure below. Doing so is dangerous as it may result in the machine losing its balance.
- Refer to page 152 "Lifting the Machine".

Transport the machine safely

- Know and follow the safety rules, vehicle code and traffic laws when transporting the machine.
- Consider the length, width, height and weight of the truck with the machine loaded on it when determining the best route.



SAFETY

Maintenance Precautions

Attach a “DO NOT OPERATE” tag

Severe injury could result if an unauthorized person should start the engine or touch controls during inspection or maintenance.

- Stop the engine and remove the key before performing maintenance.
- Attach a “DO NOT OPERATE” tag to the starter switch or control lever.

Use the correct tools

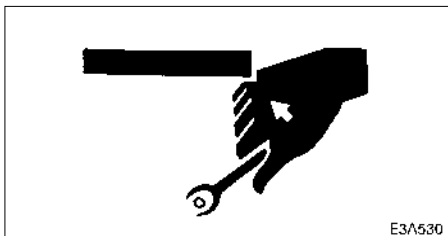

Do not use damaged or weakened tools or tools designed for other purposes. Use tools suited for the operation at hand.

Replace important safety parts periodically

- Replace fuel hoses periodically. Fuel hoses become weaker over time, even if they appear to be in good shape.
- Replace important safety parts whenever an irregularity is found, even if it is before the normal time for replacement. Refer to the section titled “Important Parts” for further details.

Anti-explosive lighting



Use anti-explosive electrical fixtures and lights when inspecting fuel, oil, coolant, battery fluid, etc. If lighting that is not anti-explosive should break, the substance could ignite, resulting in serious injury or death.

Do not allow unauthorized personnel in the work area

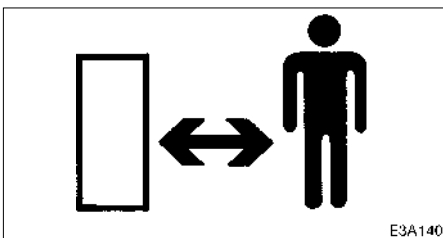

Do not allow unauthorized personnel in the work area. Chips or other debris can fly off machine parts when grinding, welding or using a hammer.



Prepare the work area

- Select a firm, level work area. Make sure there is adequate light and, if indoors, ventilation.
- Clear obstacles and dangerous objects. Eliminate slippery areas.

Stop the engine before performing maintenance

- Avoid lubrication or mechanical adjustments with the machine in motion or with the engine running while stationary.
- If maintenance must be performed with the engine running, always work as a two-person team with one person ready to shut off the engine immediately while the other works on the machine.
 - When performing maintenance, be sure to keep your body and clothing away from moving parts.

Always clean the machine

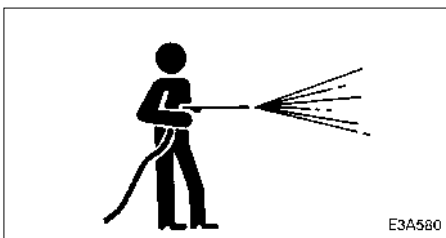

- Clean the machine before performing maintenance.
- Stop the engine and cover electrical parts when washing the machine. Water on electrical parts could cause short-circuits or malfunctions.

Do not use water or steam to wash the battery, sensors, connectors or the operator's seat area.

Stay clear of moving parts

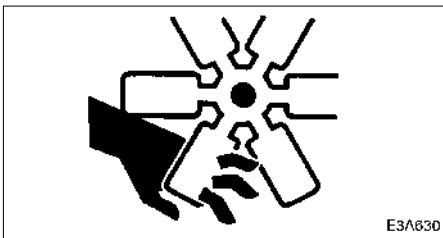

- Stay clear of all rotating and moving parts. Wrapping or entanglement may result in serious injury or death.
- Keep hands, clothing and tools away from the rotating fan and running fan belts.

**Securely block the machine or any component that may fall**

- Before performing maintenance or repairs under the machine, set all working equipment against the ground or in the lowermost position.
- Securely block the tracks.
- If you must work beneath the raised machine or equipment, always use wood blocks, jack-stands or other rigid and stable supports. Never get under the machine or working equipment if they are not sufficiently supported. This procedure is especially important when working on hydraulic cylinders.

Securely block the working equipment

To prevent unexpected movement, securely block the working equipment when repairing or replacing the cutting edges or bucket teeth.

Cautions on opening the engine hood

- Opening the engine hood while the engine is running may cause serious injury or death. Stop the engine before opening the engine hood.
- Be sure to secure the engine hood when opening it. Do not open the engine hood on slopes or in strong wind.

Place heavy objects in a stable position

When removing or installing the hoe attachment, place it in a stable position so that it does not tip over.



SAFETY

Maintenance Precautions

Use caution when fueling



- Do not smoke or permit open flames while fueling or near fueling operations.
- Never remove the fuel cap or refuel with the engine running or hot. Never allow fuel to spill on hot machine components.
- Maintain control of the fuel filler nozzle when filling the tank.
- Do not fill the fuel tank to capacity. Allow room for expansion.
- Clean up spilled fuel immediately.
- Tighten the fuel tank cap securely. Should the fuel cap be lost, replace it only with the original manufacturer's approved cap. Use of a non-approved cap without proper venting may result in pressurization of the tank.
- Never use fuel for cleaning purposes.
- Use the correct fuel grade for the operating season.

Handling of hoses

Fuel, oil or hydraulic fluid leaks can cause a fire.

- Do not twist, bend or hit the hoses.
- Never use twisted, bent or cracked hoses, tubes and pipes. They may burst.
- Retighten loose connections.

Be careful with hot and pressurized components



Stop the engine and allow the machine to cool down before performing inspection and maintenance.

- The engine, muffler, radiator, hydraulic lines, sliding parts and many other parts of the machine are hot directly after the engine is stopped. Touching these parts will cause burns.
- The engine coolant, oil and hydraulic fluid are also hot and under high pressure. Be careful when loosening caps and plugs. Working on the machine under these conditions could result in burns or injuries due to the hot oil spurting out.

Be careful with hot cooling systems

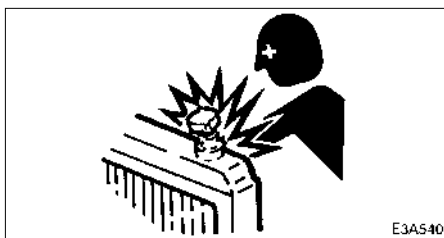

Do not remove the radiator cap or drain plugs when the coolant is hot. Stop the engine, let the engine and radiator cool and loosen the radiator cap or drain plugs slowly.



Be careful with fluids under pressure

Pressure can be maintained in the hydraulic circuit long after the engine has been shut down.

- Release all pressure before working on the hydraulic system.

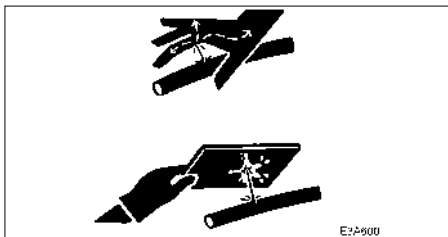

- Hydraulic fluid under pressure can penetrate the skin or eyes and cause injury, blindness or death. Fluid escaping from a small hole can be almost invisible. Wear a safety goggles and heavy gloves and use a piece of cardboard or wood to search for suspected leaks. If fluid is injected into the skin, it must be removed within a few hours by a doctor familiar with this type of injury.

Release all pressure before working on the hydraulic system

Oil may spurt out if caps or filters are removed or pipes disconnected before releasing the pressure in the hydraulic system.

- Gradually loosen the vent plug to relieve tank pressure.
- Move all the control levers and pedals several times in all directions to release the pressure from the working equipment circuitry. (For link type controls)
- When removing plugs or screws or disconnecting hoses, stand to the side and loosen slowly to gradually release the internal pressure before removing.

Be careful with grease under pressure



The track adjuster contains highly pressurized grease. If the tension is adjusted without following the prescribed procedure, the grease discharge valve may fly off, resulting in injury.

- Do not loosen the grease nipple.
- Loosen the grease discharge valve slowly.
- Do not put your face, arms, legs or body in front of the grease discharge valve.
- If no grease is expelled when grease discharge valve is loosened, there is a problem. Contact your nearest service outlet for repairs. DO NOT disassemble, as this is very dangerous.



Disconnect the battery

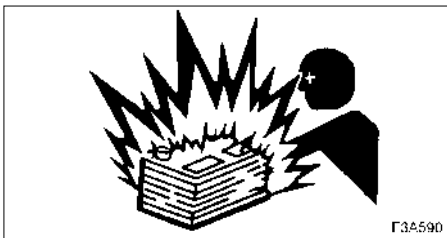

Disconnect the battery before working on the electrical system or doing any welding. Remove the negative (-) battery cable first. When reconnecting the battery, connect the negative (-) battery cable last.

Avoid battery hazards

- Batteries contain sulfuric acid which will damage eyes or skin on contact.
 - If acid contacts eyes, flush immediately with clean water and get prompt medical attention.
 - If acid is accidentally swallowed, drink large quantities of water or milk and call a physician immediately.
 - If acid contacts skin or clothing, wash off immediately with clean water.
- Wear safety glasses and gloves when working with batteries.
- Batteries generate flammable and explosive gases. Keep arcs, sparks, flames and lighted tobacco away.
- Use a flashlight to check battery electrolyte level.
- Stop the engine and shut off electrical equipment while inspecting or handling the battery.
- Do not short circuit the battery posts with metal items.
- Always unfasten the negative (-) battery cable first when disconnecting the battery cable. Always connect the negative (-) battery cable last when fastening the battery cable.
- Loose battery terminals may result in sparks. Be sure to fasten terminals tightly.
- Make sure the vent caps are tightened securely.
- Do not charge a battery or jump-start the engine if the battery is frozen. Warm to 15°C (60°F) or the battery may explode.
- Do not use the battery when the fluid level is below the lower level. Doing so will hasten the deterioration of the internal portions of the battery and shorten the battery life, and can also cause rupturing (or an explosion).
- Do not fill the battery above the upper level. Doing so could cause the fluid to leak, contact and damage the skin, or cause parts to corrode.



Have a Takeuchi service agent repair welding cracks or other damage

Ask a Takeuchi service agent to repair any welding problems which are detected. If not feasible, make sure the welding is done by a qualified person in a properly equipped workplace.

Checks after maintenance

- Gradually raise the engine speed from a low idle to maximum speed and check that no oil or water is leaking from serviced parts.
- Move the controls and check that the machine is operating properly.

Disposing of wastes

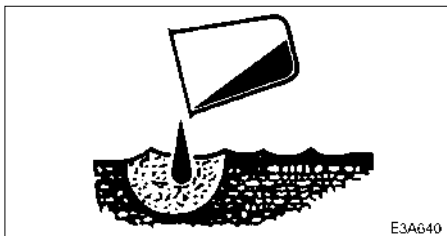

- Funnel spent fluids from the machine into containers. Disposing of fluids improperly destroys the environment.
- Follow the prescribed regulations when disposing of oil, fuel, engine coolant, refrigerant, solvents, filters, batteries or other harmful substances.



The following safety signs (decals) have been placed on your machine in the areas indicated. They are intended for the personal safety of you, and those working with you. Please take this manual, walk around your machine and note the content and location of these safety signs. Review these signs and the operating instructions in this manual with your machine operators.

- Keep the signs legible. If they are not, obtain replacements from your Service outlet.

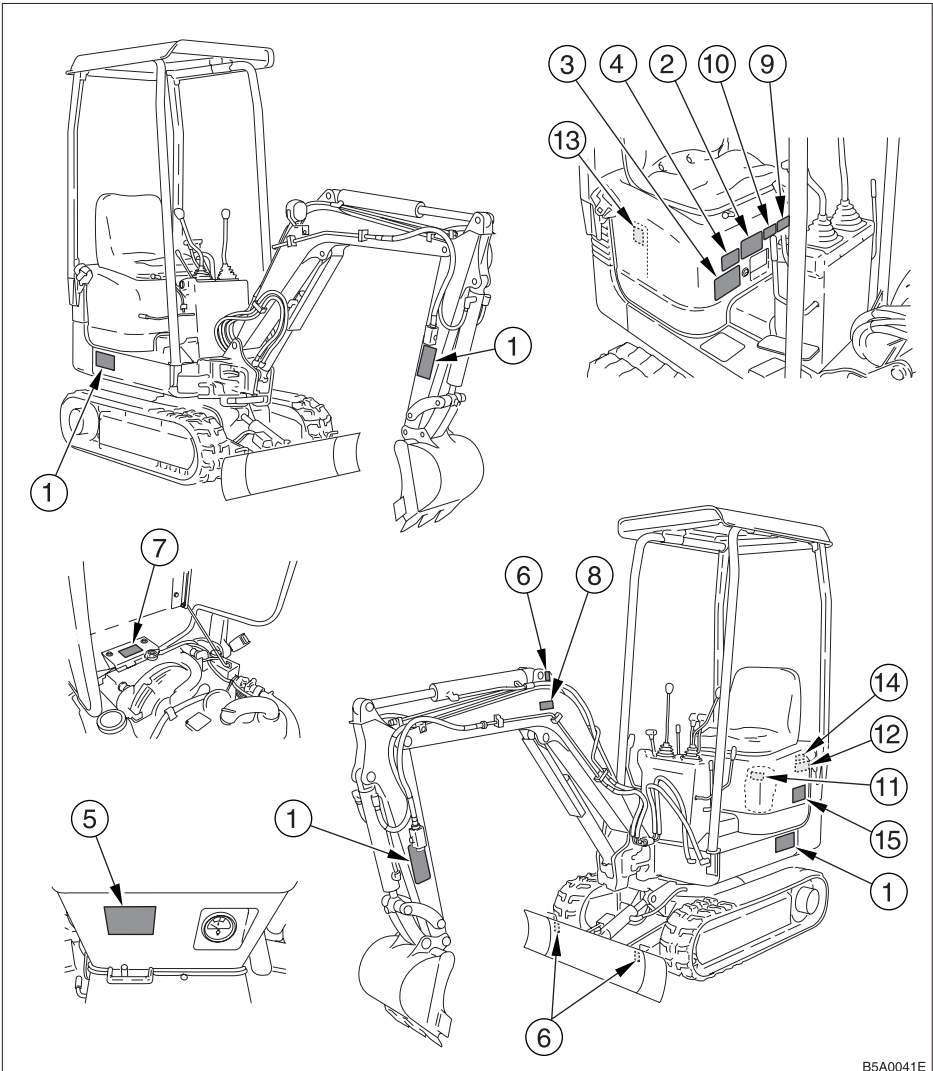



SAFETY

Safety Signs (decals)

1. No.03593-06500



5. No.03593-32300

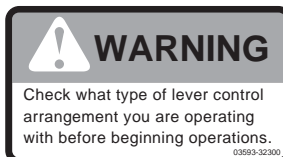

2. No.03393-79820



6. No.03993-00500
Position of Hoisting



3. No.03593-13700

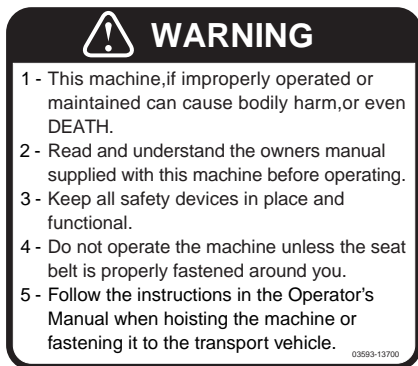

7. No.05693-21980



8. No.03593-47010



4. No.03593-07400



9. No.03593-47020





SAFETY

Safety Signs (decals)

10. No.03393-68100



11. No.03393-75040



12. No.03393-75050



13. No.03593-06600

Diesel Fuel



14. No.03593-06700

Hydraulic oil



15. No.03293-64601

Noise Outside the Cab

This value indicates the noise level outside the machine and refers to the noise perceived by the persons who are in the vicinity of the work area.

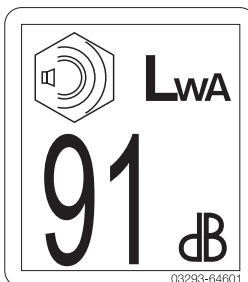



CONTROLS

Names of Components	36
Doors and Covers	38
Seat and Seat Belt	40
Instruments	41
Switches	42
Levers and Pedals	43
Accessories	47

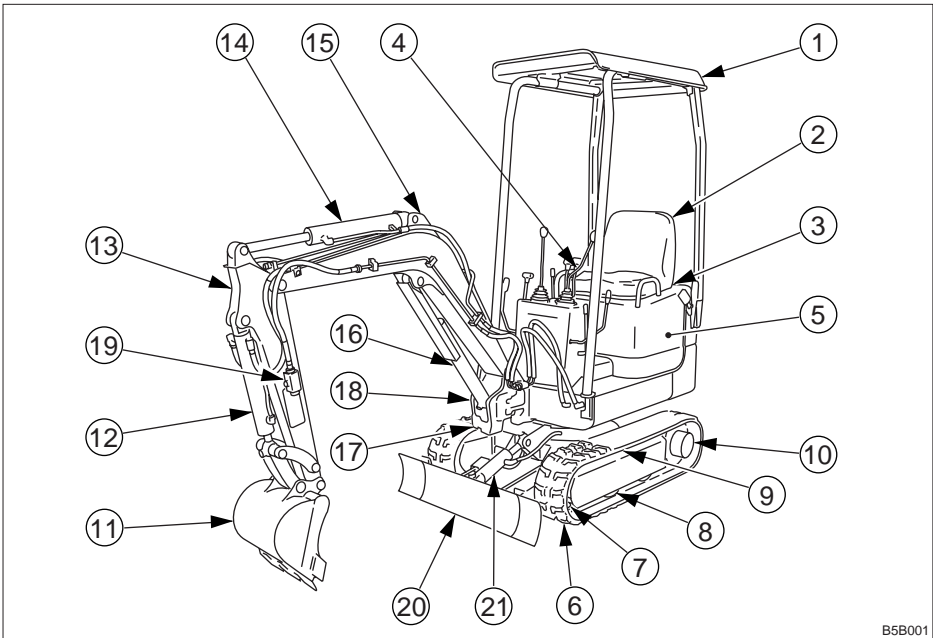

B5B001

Upperstructure

- 1. Canopy
- 2. Seat
- 3. Engine hood
- 4. Fuel tank
- 5. Hydraulic tank

Undercarriage

- 6. Crawler belt
- 7. Idler
- 8. Track roller
- 9. Shoe slide
- 10. Travel motor

Working equipment

- 11. Bucket
- 12. Bucket cylinder
- 13. Arm
- 14. Arm cylinder
- 15. Boom
- 16. Boom cylinder
- 17. Boom bracket
- 18. Swing cylinder
- 19. Auxiliary hydraulic line
- 20. Dozer blade
- 21. Blade cylinder

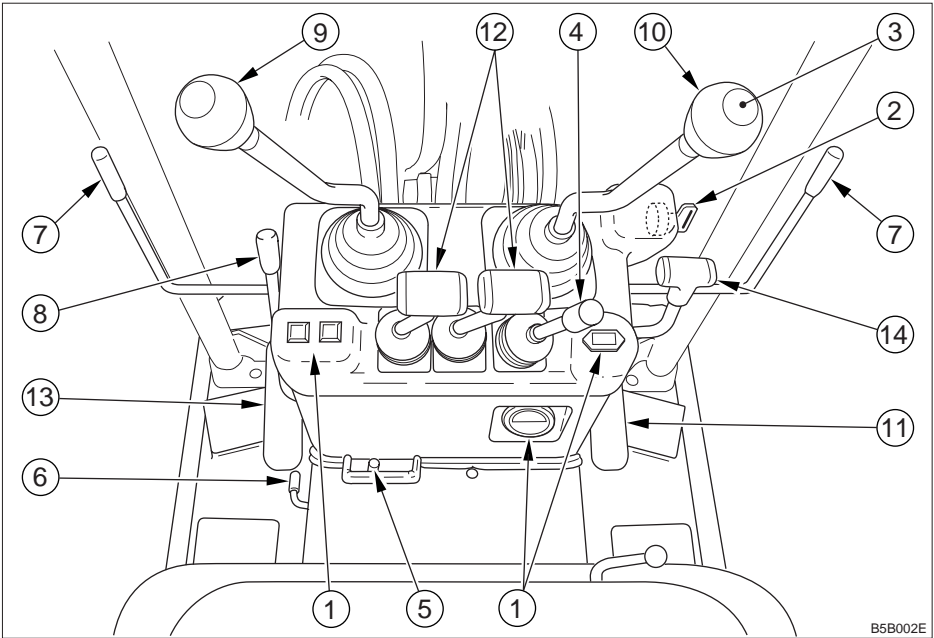

B5B002E

- | | |
|-----------------------|---------------------------|
| 1. Instruments | 8. Throttle lever |
| 2. Starter switch | 9. Left operating lever |
| 3. Horn switch | 10. Right operating lever |
| 4. Travel speed lever | 11. Boom swing pedal |
| 5. Selector lever | 12. Travel lever |
| 6. Slew lock lever | 13. Auxiliary pedal |
| 7. Safety lock lever | 14. Blade lever |



Starter Key

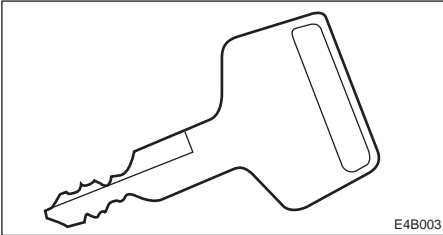

The starter key is used not only to start and stop the engine, but also to lock and unlock the following places:

- Engine hood

Engine Hood

WARNING

- Before opening the engine hood, be sure to stop the engine. If your hands or tools should get caught in the fan or fan belt while the engine is running they may be severed.
- When leaving the engine hood open, be sure to lock it in place. Do not leave the engine hood open when there is a strong wind or when on slopes.
- When opening and closing the engine hood, be careful not to get your hands or other parts of your body caught.

Opening

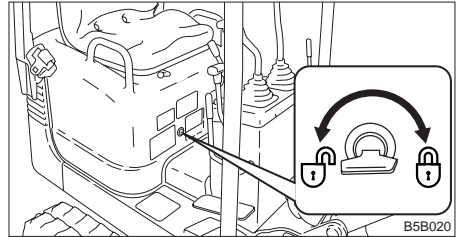

1. Insert the starter key and turn it counterclockwise to unlock the engine hood.

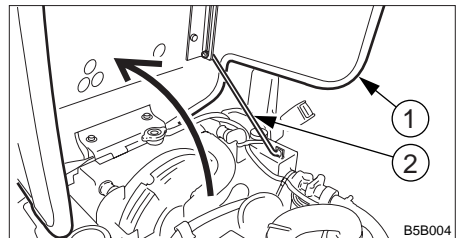

2. Lift the engine hood (1) fully.
3. Check that the engine hood is securely locked in place.

Closing

1. Support the engine hood by hand and pull the stay (2) to the front to unlock it.
2. Close the engine hood (1) and press it down until a click is heard at the front.



Fuel Filler Cap

WARNING

- Do not smoke or permit open flames while fueling or near fueling operations.
- Supply fuel in a well ventilated place and with the engine stopped.
- Clean up spilled fuel immediately.
- Do not fill the fuel tank to capacity. Allow room for expansion.
- Tighten the fuel filler cap securely.

Opening and closing

1. Open the engine hood.

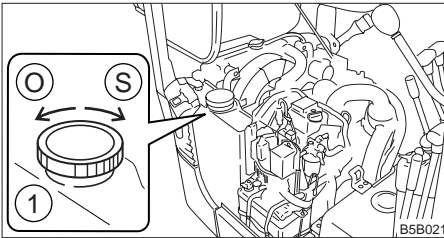

⊙ : Open ⊙ : Closed

2. Turn the fuel filler cap (1).

Manual Case (option)

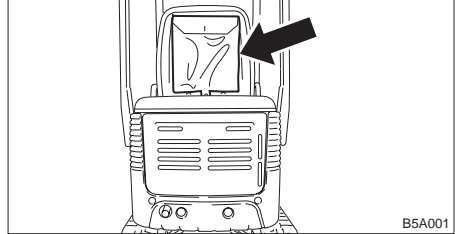

**Seat****⚠ WARNING**

Adjust, secure and latch the operator's seat.

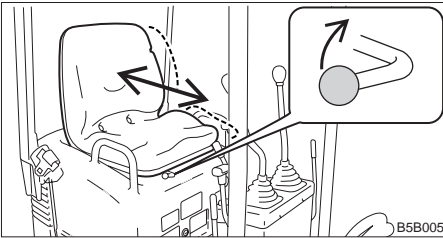
Fore-and-aft adjustment

1. Pull on lever and slide the seat backward or forward to bring it to the optimum position for operating the machine.
2. Release the lever at the desired position and the seat will remain fixed there.

Seat Belt**⚠ CAUTION**

Always fasten the seat belt securely before starting the engine.

Fastening the seat belt

1. Adjust the seat to the optimum position for operating, raise your torso, and sit back firmly into the seat.
2. Pull the seat belt to the desired length.

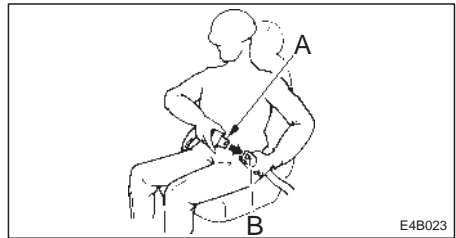

3. Make sure that the belt is not twisted and then insert the tongue plate (A) into the buckle (B) of the seat belt until you hear a clicking sound as it locks in place.

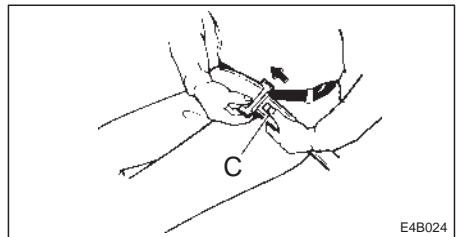
Releasing the seat belt

1. To remove the seat belt, simply press the button (C) located on the buckle. The seat belt is automatically stowed away.

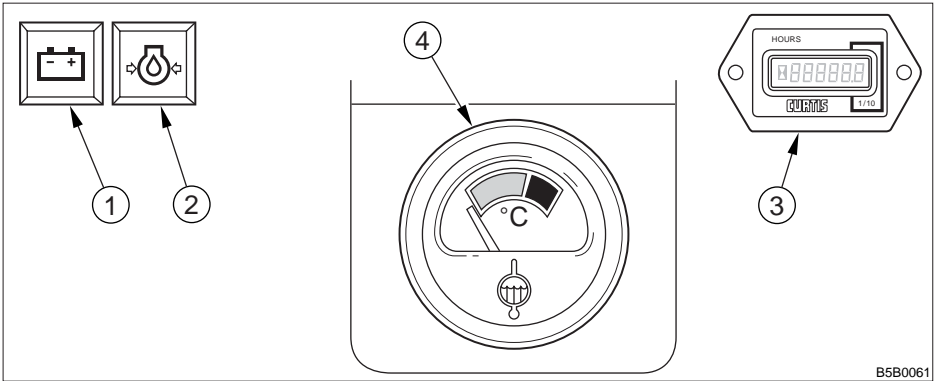

B5B0061

Warning Lamps

IMPORTANT: If a warning lamp lights, stop all operations immediately and inspect and maintain the appropriate part. Refer to page 131 "Troubleshooting".

1. Battery Charge Warning Lamp

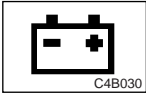

This lamp lights if a problem arises in the charging system while the engine is running.

2. Engine Oil Pressure Warning Lamp



This lamp lights if the lubricant oil pressure drops abnormally while the engine is running.

Meters

3. Hour Meter

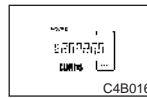

This displays the total engine running time in hours.

The rightmost digit indicates tenths of hours (6 minutes).

Set the inspection and maintenance intervals according to the time displayed on the hour meter.

4. Water Temperature Gauge



This indicates the temperature of the engine coolant.

The needle should be within the green range during machine operation. The red range indicates overheating.



Starter Switch

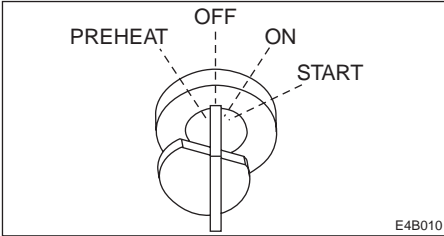

IMPORTANT: Do not repeatedly switch the key from OFF to ON and ON to OFF over a short period. Doing so will cause engine breakdown.

PREHEAT Position for preheating the engine.

OFF Position for stopping the engine and inserting or removing the key.

ON Position in which the engine is running. At this position, all the electrical equipment is functional.

START Position for starting the engine. When the key is released, the switch automatically returns to the ON position.

Horn Switch

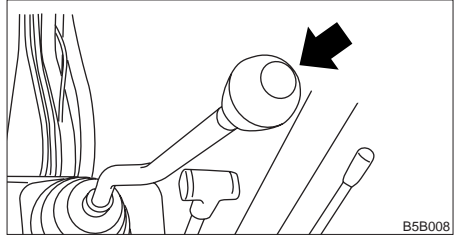

Press the switch on the right operating lever to blow the horn.

Boom Light

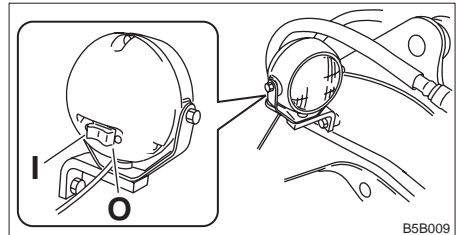

When the switch is depressed while the starter switch is at ON, the light turns on or off as follows:

O Off

I On



Safety Lock Lever

WARNING

- Before leaving the operator's seat, raise the safety lock lever to engage the lock and stop the engine. If any controls should be touched accidentally when the safety lock lever is lowered, the machine will move suddenly, and cause serious injury or death.
- Note that the dozer blade, boom swing and auxiliary hydraulics controls are not locked, even when the safety lock lever is set to the lock position. Do not touch these controls accidentally.
- Be careful not to touch the operating levers when raising and lowering the safety lock lever.

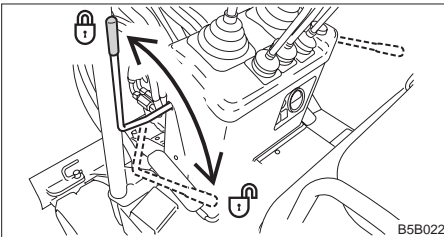

This device is for locking the hoe attachment, slewing and traveling. When the safety lock lever is raised, the operating and travel levers are locked.

Slew Lock Lever

WARNING

Engage the slew lock when traveling, parking or transporting the machine.

IMPORTANT: Do not try to slew when the slew lock lever is set to the locked position.

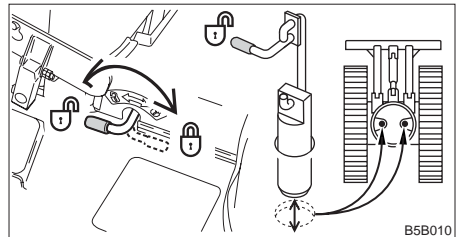

Use this lever to lock the upperstructure so that it cannot slew.

- Turn the lever forward to unlock.
- When setting to the locked position, always line up the upperstructure and undercarriage and turn the lever backward to lock.
- If the upperstructure and undercarriage are not lined up, slewing will not be locked even if the lever is set to the locked position.



Throttle Lever

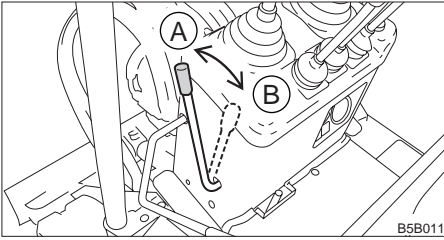

B5B011

This controls the engine speed.

- (A) Low idling
- (B) Maximum speed

Blade Lever

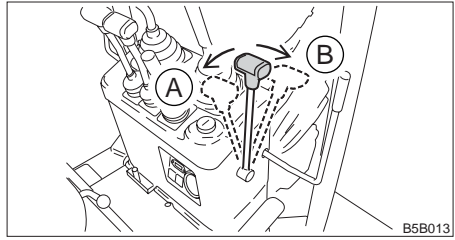

B5B013

Use this lever to operate the dozer blade and switch the crawler width.

- (A) Blade up/narrow crawler width
- (B) Blade down/wide crawler width

To change the crawler width, press the selector lever in before operating it.

Refer to page 60 “Changing the Crawler Width”.

Operating Levers



WARNING

- Be careful to check which pattern of lever control arrangement you are operating with before beginning operations.
- The explanations in this manual are for the ISO pattern.

Travel Levers



WARNING

Before operating the travel levers, check to make sure that the dozer blade is to the front of the operator’s seat. **BE AWARE** that when the dozer blade is to the rear of the operator’s seat, the travel levers operate in the opposite direction to when the dozer blade is in the front.

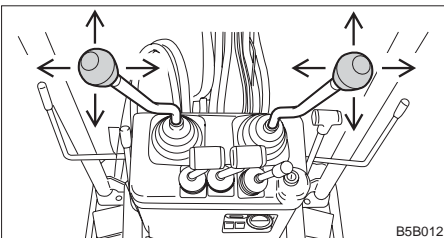

B5B012

Use these levers to operate the boom, arm, bucket and upperstructure (slew).

Refer to pages 56, 57 “Lever Pattern”.

Refer to page 64 “Operating the Working Equipment”.

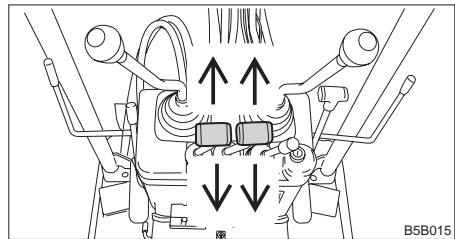

B5B015

Use these levers to move forward and backward and to change directions.

Refer to page 61 “Operating the Travel Levers”.



Travel Speed Lever

⚠ CAUTION

It is not possible to change directions when traveling in 2nd (high) speed. To change directions, first release the travel speed lever to uncouple the travel levers.

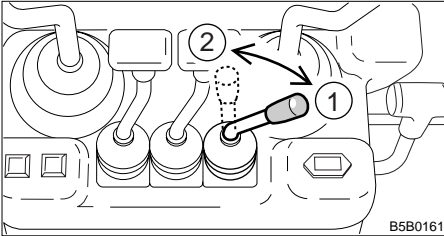

The travel speed lever switches the machine travel speed.

(1) 1st (low) speed

(2) 2nd (high) speed

In 2nd speed, the left and right travel levers are coupled so only straight travel is possible.

Boom Swing Pedal

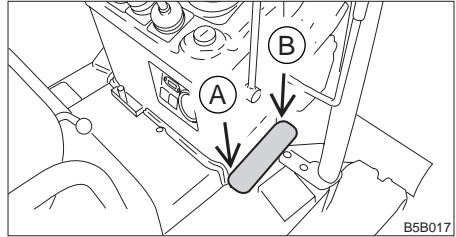

Use this pedal to operate the boom swing.

(A) Boom swing right

(B) Boom swing left

Auxiliary Pedal

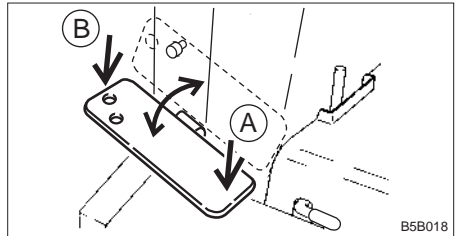

This pedal controls the flow of the oil in the auxiliary hydraulic circuit.

(A) Hydraulic oil flows to left auxiliary hose

(B) Hydraulic oil flows to right auxiliary hose



Pedal Stopper

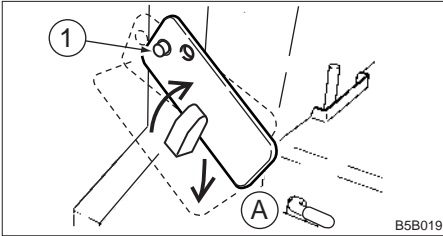

This is a device for fixing the auxiliary pedal to the operating status so that when using with a hand breaker, etc., connected to the auxiliary ports, the hand breaker can be turned on and off using it's own switch.

1. Lift the pedal and press on the heel side (A).
2. Put the bolt (1) through the hole in the pedal to lock it.

Selector Lever

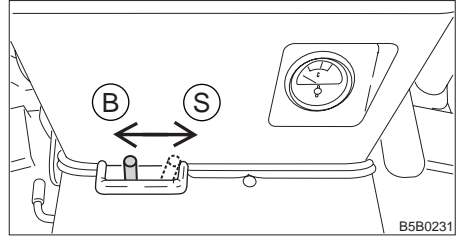

Use this lever when changing the crawler width. This lever switches the operation of the blade and span cylinder.

1. To change the crawler width, move this lever to the right (S).
2. Move the blade lever and change the crawler width.



Auxiliary Hydraulic Lines

WARNING

Oil may spurt out if caps or filters are removed or pipes disconnected before releasing the pressure in the hydraulic system.

- When removing plugs or disconnecting hoses, release the internal pressure before removing.

These lines deliver the hydraulic oil necessary for operating a hydraulic breaker, crusher or other attachments.

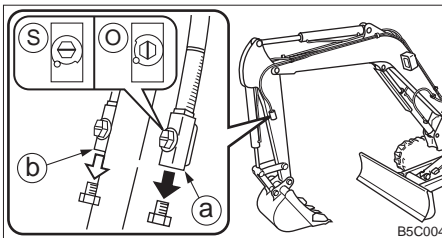
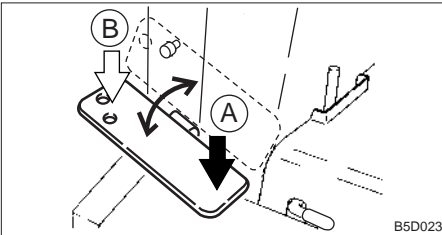

Stop valve (S) : Closed (O) : Open

Connecting the Hydraulic Circuits

To connect the attachment hydraulic lines, use the following procedures:

1. Move the auxiliary pedal several times to relieve pressure on the lines.
2. Make sure the stop valves are closed.
3. Remove the plugs.
4. Connect the attachment hydraulic lines to ports (a) and (b).
5. Open the stop valves.
6. When connecting is complete, purge air from the hydraulic lines.
 - a. Start and run the engine at low idle with no load for 10 minutes.
 - b. With the engine running at low idle operate the auxiliary pedal repeatedly (approx. 10 times) to purge air from the hydraulic lines.
 - c. Stop the engine and wait for more than 5 minutes until bubbles escape from the hydraulic oil in the tank.

IMPORTANT: Follow the procedures for purging air as instructed by the attachment manufacturer if specified to do so.

7. Check for leaks.

Before dismantling the attachment, move the auxiliary pedal several times to relieve pressure on the lines and be sure to close the stop valves.



External Power Socket (for EU)

 **WARNING**

Only use applicable electric products with this socket.

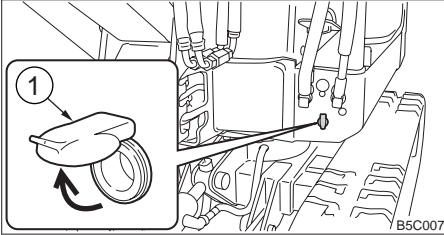

Use this socket as an external power supply.
To use, raise the cap (1).



The operating pattern of the left and right operating levers can be changed.

! WARNING

Be careful to check which pattern of lever control arrangement you are operating with before beginning operations.

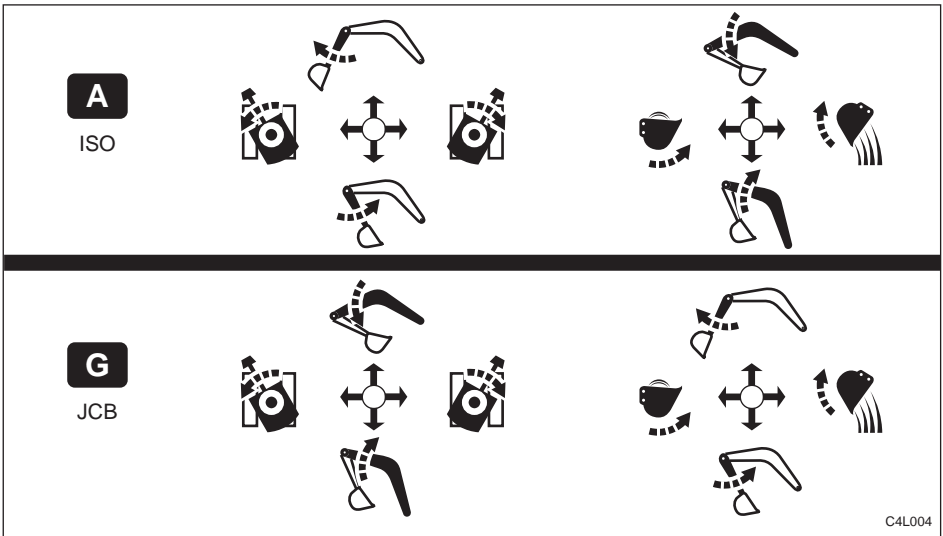

Switching the Lever Pattern

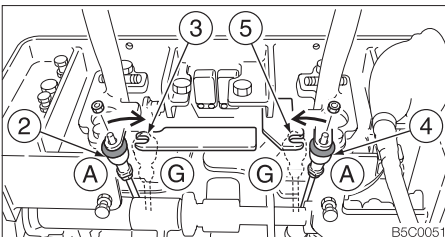

3. Switch rod (2) to plate (3).
4. Switch rod (4) to plate (5).
5. Set the boots and cover back as they were.
6. Check the lever pattern.

(A) : ISO pattern

(G) : JCB pattern

1. Remove the lower mount section of the boots and turn them upwards.
2. Loosen the bolts and remove the cover.



OPERATION

Before Starting Operation	52
Starting and Stopping the Engine	53
Machine Operation	56
Operating Procedures	67
Parking the Machine	75
Handling in Cold Weather	76
Handling Rubber Crawlers	77

**Mounting and Dismounting****⚠ WARNING**

- **Do not jump on or off the machine. Never attempt to mount or dismount a moving machine.**
- **When mounting and dismounting the cab, first open the door fully to the locked position and check that it does not move. (For machines with cabs)**

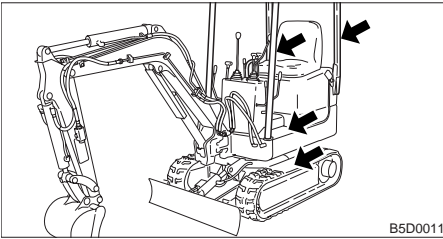

- **Always face the access system and maintain a three point contact with the recommended handrails and steps while getting on and off the machine. Keep steps and platform clean.**
- **Never use the safety lock lever or control levers as hand holds.**

Walk-Around Inspection

Perform the walk-around inspections before starting the engine the first time that day. Perform the inspections as described under “Maintenance - Walk-Around Inspection” (pages 95 and 96).

Daily Inspection

Perform the daily inspections once a day before starting the engine the first time that day. Perform the inspections as described under “Maintenance - Daily Inspection” (pages 97 to 101).

**Before Starting the Engine**

1. Adjust the seat for a comfortable operating position.
2. Fasten your seatbelt.

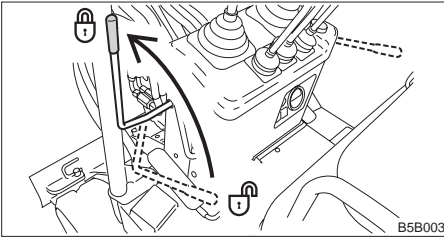

3. Check that the safety lock lever is in the locked position.

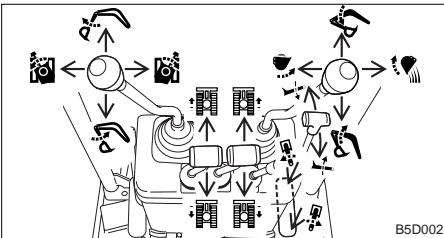

4. Check that all the levers and pedals are in the neutral position.

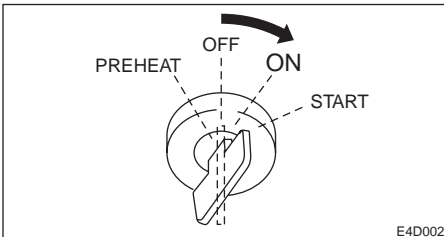

5. Insert the key into the starter switch, turn it to the ON position, then perform the following inspection:

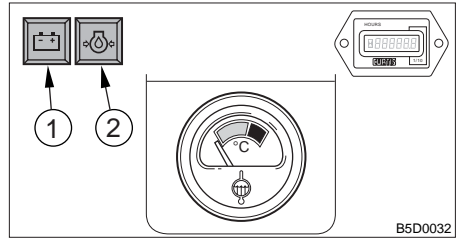

- The battery charge warning lamp (1) and engine oil pressure warning lamp (2) light, and the meters also start functioning.

If a lamp does not light, the bulb may be burnt out or a wire may be damaged. Contact a Takeuchi sales or service outlet for repairs.

**Starting the Engine****⚠ WARNING**

- Clear the area of all persons.
- Sound horn to alert everyone around the machine.

IMPORTANT: Do not run the starter motor for more than 15 consecutive seconds. If the engine fails to start, wait for 30 seconds to protect the battery, and then try again to start the engine.

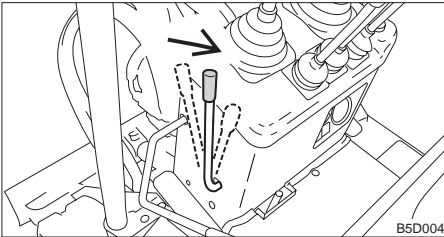
Normal Starting

1. Pull the throttle lever to the middle position.

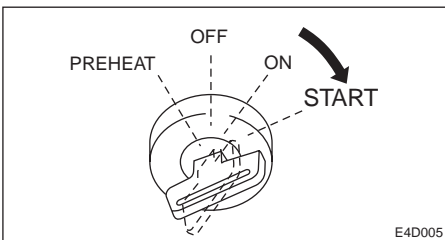

2. Turn the key to the START position and start the engine.
3. Once the engine starts, release the key. The key automatically returns to the ON position.
4. Return the throttle lever.
5. Check that the warning lamps are off.
6. Warm up the engine.
Refer to page 55 "Warming Up the Engine".

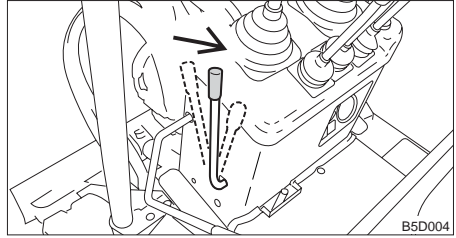
Starting in Cold Weather

1. Pull the throttle lever to the middle speed position.

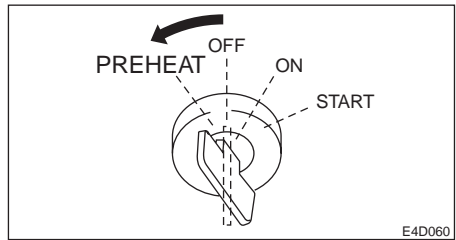

2. Turn the key to the PREHEAT position and hold it there about 3 seconds.
3. Turn the key to the START position and start the engine.
4. Once the engine starts, release the key. The key automatically returns to the ON position.
5. Return the throttle lever.
6. Check that the warning lamps are off.
7. Warm up the engine.
Refer to page 55 "Warming Up the Engine".

**Warming Up the Engine**

IMPORTANT: Avoid racing the engine until it is warmed up.

Do not warm up the engine for long periods of time (20 minutes or more).

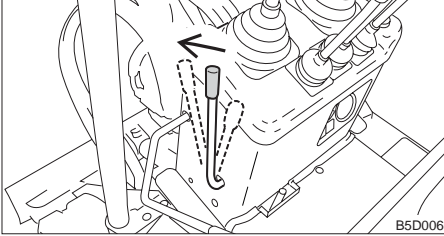

1. Return the throttle lever, then idle the engine and run it for about 5 minutes with no load.

Stopping the Engine

IMPORTANT: Do not stop the engine suddenly when operating with heavy loads or at maximum speed. Doing so may cause the engine to overheat or seize. Never bring the engine to a sudden stop except in the case of a true emergency.

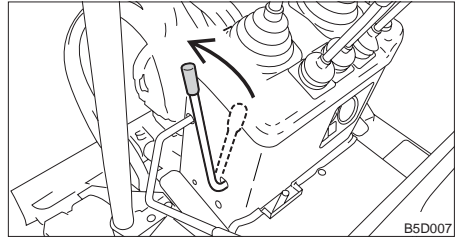

1. Idle the engine for about 5 minutes to gradually let it cool.

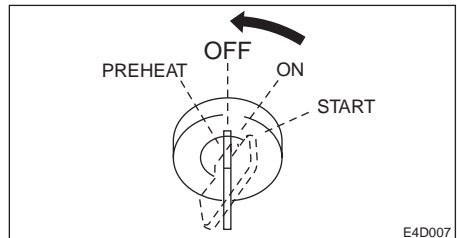

2. Turn the key to the OFF position to stop the engine.



Lever Pattern (ISO Pattern)

WARNING

- Be careful to check which pattern of lever control arrangement you are operating with before beginning operations.
- The explanations in this manual are for the ISO pattern.

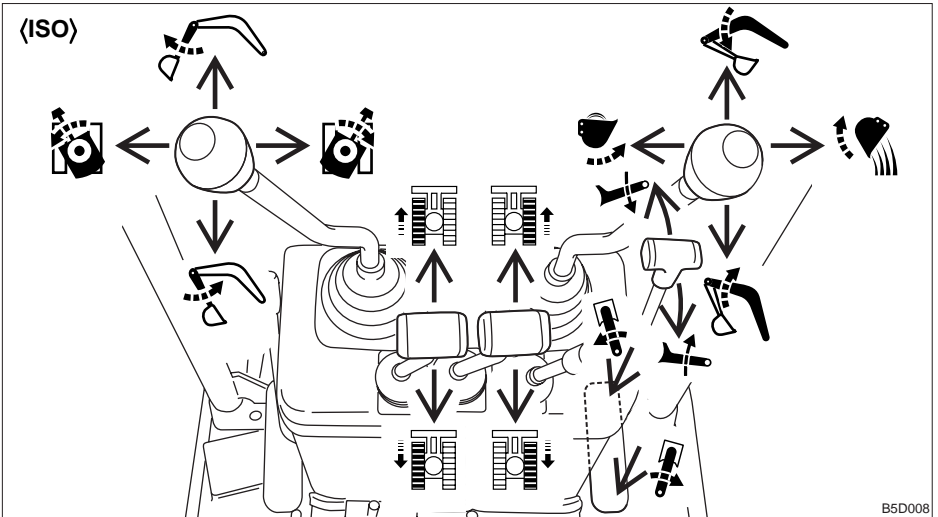

B5D008

	Left Crawler Forward		Right Crawler Forward
	Left Crawler Reverse		Right Crawler Reverse
	Arm Out		Boom Lower
	Arm In		Boom Raise
	Upperstructure Slew Left		Bucket Load
	Upperstructure Slew Right		Bucket Dump
	Boom Swing Left		Dozer Blade Lower
	Boom Swing Right		Dozer Blade Raise



Lever Pattern (JCB Pattern)

! WARNING

- Be careful to check which pattern of lever control arrangement you are operating with before beginning operations.
- The explanations in this manual are for the ISO pattern.

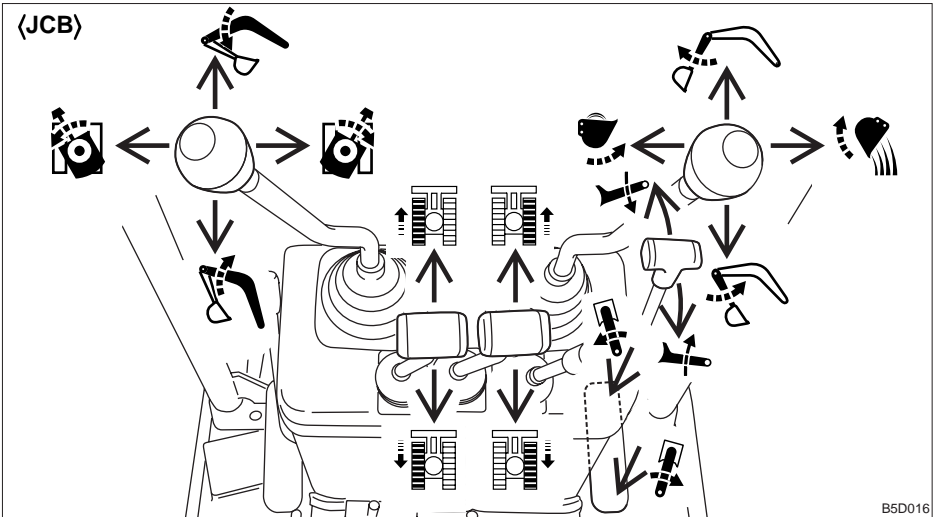

B5D016

	Left Crawler Forward		Right Crawler Forward
	Left Crawler Reverse		Right Crawler Reverse
	Boom Lower		Arm Out
	Boom Raise		Arm In
	Upperstructure Slew Left		Bucket Load
	Upperstructure Slew Right		Bucket Dump
	Boom Swing Left		Dozer Blade Lower
	Boom Swing Right		Dozer Blade Raise



Warming Up the Machine (Hydraulic Oil)

⚠ WARNING

Operating the working equipment without warming up the machine (hydraulic oil) is dangerous, as response will be slow and the equipment may move in unexpected ways. Be sure to sufficiently warm up the machine.

IMPORTANT: Do not operate the levers suddenly when the hydraulic oil temperature is below 20°C (68°F). The proper hydraulic oil temperature during operation is 50 to 80°C (122 to 176°F), but if operations must be performed at lower temperatures, heat up the hydraulic oil to at least 20°C (68°F).

Normal Warm-up

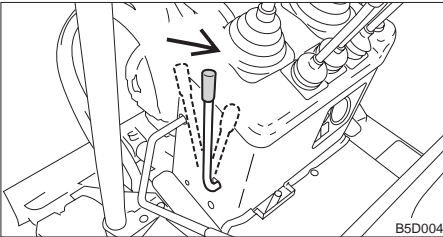

1. Pull the throttle lever to the middle position, then run the engine at medium speed for about 5 minutes with no load.

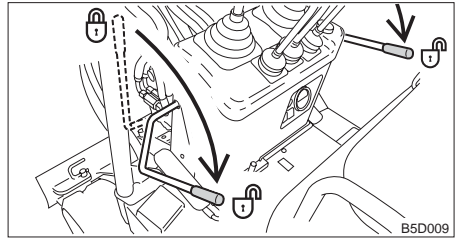

2. Fully lower the safety lock lever to disengage the lock and lift the bucket from the ground.

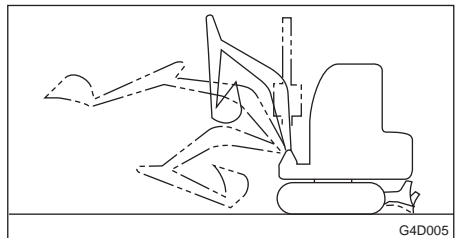

3. Extend and retract each of the cylinders several times with no load.

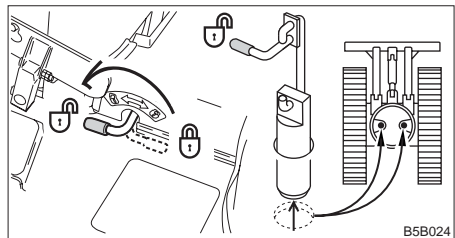

4. Set the slew lock lever to the released position before starting to slew.

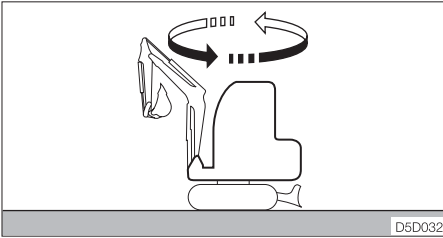

5. Slew slowly left and right several times.

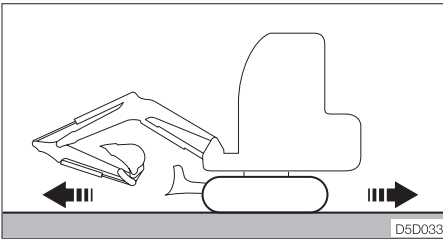

6. Travel slowly forward and backward several times.

Warming Up in Cold Weather

1. Perform the normal warm-up procedure. Refer to the previous page.

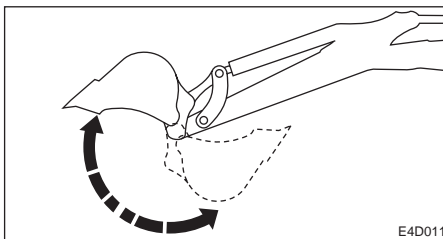

2. Set the bucket cylinder at the stroke end and keep it there.
Do not do this for more than 30 seconds.
3. Repeat step 2 until the bucket operating speed is normal.

Inspection After Warm-up

After warming up the engine and hydraulic oil, perform the checks and inspections described below, and repair if there is a problem.

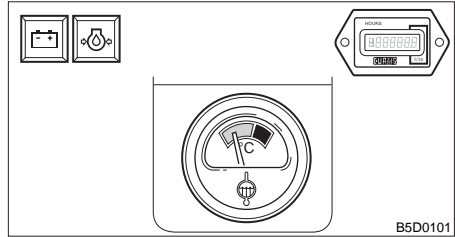

1. Check that the warning lamps and meters are as follows:
 - Are all the warning lamps off?
 - Is the water temperature gauge's needle within the green range?
2. Check that there are no irregularities in the exhaust color, sound and vibrations.

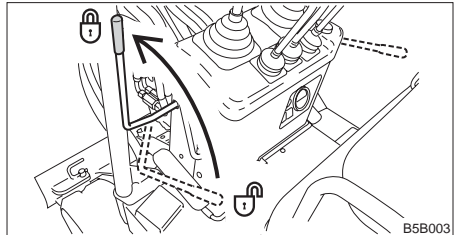

3. Raise the safety lock lever to engage the lock and check that the operating and travel levers are locked.



Changing the Crawler Width

WARNING

Always operate the machine with the crawler width at the maximum to increase machine stability. The smaller the crawler width, the greater the possibility the machine can tip over. If it is absolutely necessary to operate the machine with a narrow crawler width, do so with great care.

Perform these operations on a flat, solid surface with no obstacles in the way.

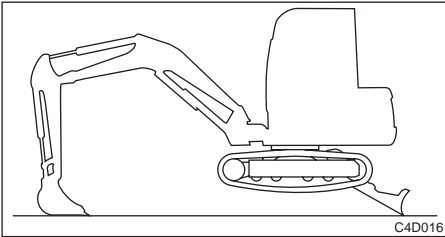

1. Lift the machine body using the hoe attachment and dozer blade.

IMPORTANT: Always lift the body before changing the crawler width. Failure to do so can result in damage to the track frames and spanner cylinder.

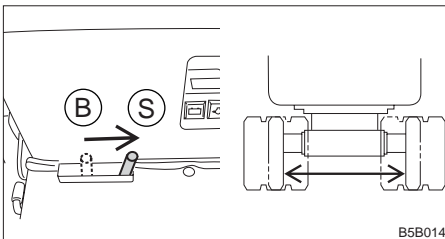

2. Move the selector lever to the right (S).

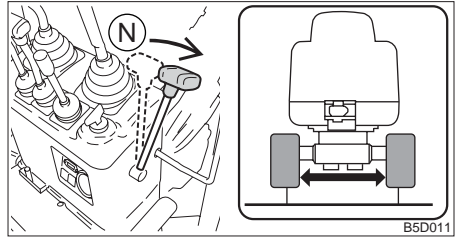

3. Push the blade lever forward to extend crawler width.

- →900mm (35.4 in.)

If necessary, also replace the blade's plates and use the dozer blade with the extended width.

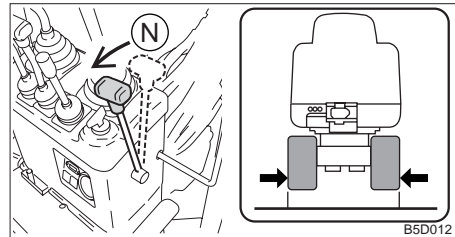

4. Pull the blade lever backward to retract crawler width.

- →680mm (26.8 in.)



Changing the Dozer blade width

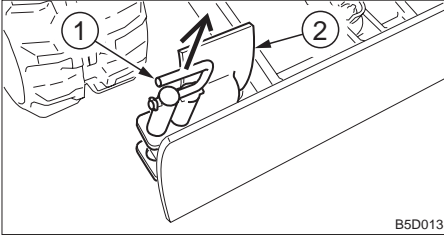

1. Pull out the lock pins (1).

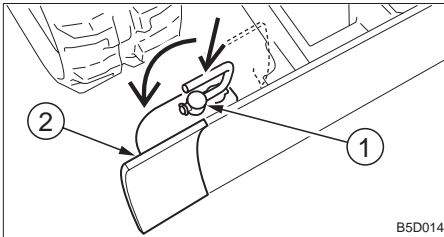

2. Turn the plate (2).
3. Secure the plate (2) with the lock pins (1).

Operating the Travel Levers

⚠ WARNING

- Never allow anyone to enter the slewing (swing) radius and machine path.
- Signal your intention to move by sounding the horn.
- There are blind spots to the rear of the machine.

If necessary, slew the cab around before backing up to check that the area is safe and clear.

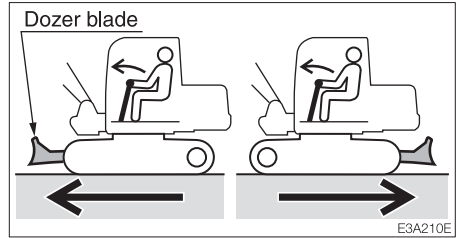

- Before operating the travel levers, check to make sure that the dozer blade is to the front of the operator's seat. **BE AWARE** that when the dozer blade is to the rear of the operator's seat, the travel levers operate in the opposite direction to when the dozer blade is in the front.
- Remove any obstacles in the machine's path.

Traveling Forward and Backward

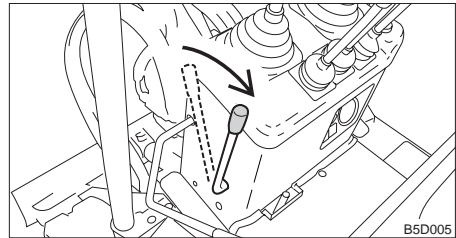

1. Pull the throttle lever and increase the engine speed.

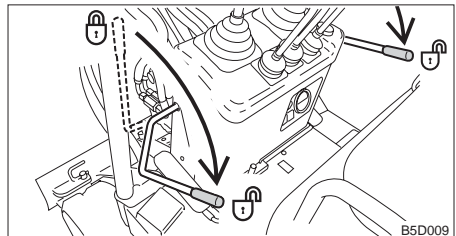

2. Lower the safety lock lever to the released position.

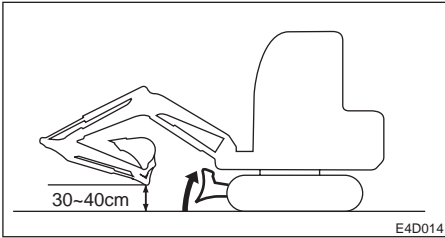

3. Fold the hoe attachment and lower it to 30 to 40 cm (12 to 16 in.) above the ground.
4. Lift the dozer blade.
5. Operate the left and right travel levers as described below.

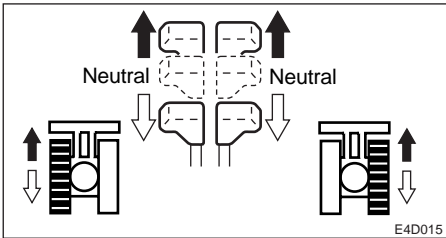

When the dozer blade is in front of the operator's seat:

- ➔ To move forward:
Tilt the levers forward.
- ⇨ To move backward:
Tilt the levers backward.

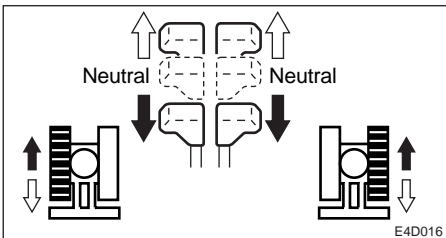

When the dozer blade is behind the operator's seat:

- ➔ To move forward:
Tilt the levers backward.
- ⇨ To move backward:
Tilt the levers forward.

Traveling in 2nd (High) Speed



It is not possible to change directions when traveling in 2nd (high) speed. To change directions, first release the travel speed lever to uncouple the travel levers.

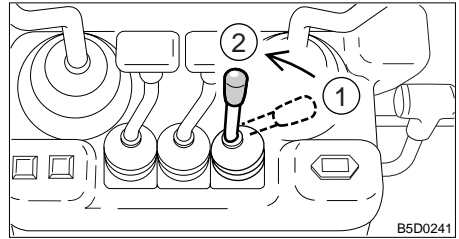

1. Tilt the travel speed lever fully to the left and grasp the right travel lever with the same hand.
2. Tilt the levers forward or backward to travel straight in 2nd speed.
3. Release the travel speed lever to return to 1st (low) speed.

Pivot Turn

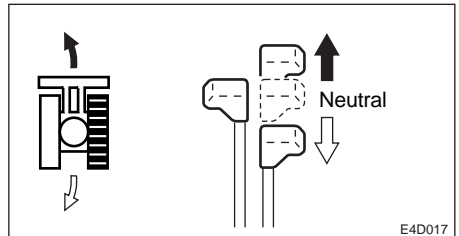

Turning to the left when stopped:

- ➔ To turn forward to the left:
Tilt the right lever forward.
 - ⇨ To turn backward to the left:
Tilt the right lever backward.
- To turn to the right, operate the left lever in the same way.

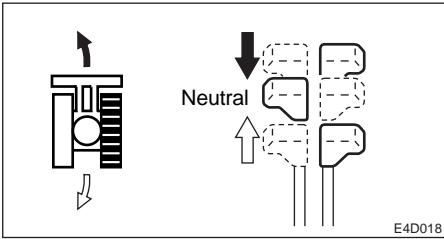

E4D018

Turning to the left while traveling:

➔ To turn left while traveling forward:

Set the left lever to neutral.

⇨ To turn left while traveling backward:

Set the left lever to neutral.

To turn to the right while traveling, operate the right lever in the same way.

Spin Turn

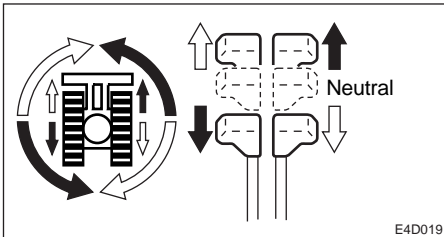

E4D019

➔ To spin left:

Tilt the left lever backward and the right lever forward.

⇨ To spin right:

Tilt the right lever backward and the left lever forward.

Stopping Travel

WARNING

- Park the machine on firm, level ground and apply the parking device. If you must park on a slope or incline, block the machine securely to prevent movement.
- If any controls should be touched accidentally when the safety lock lever is lowered, the machine will move suddenly, and cause serious injury or death.
- Note that the dozer blade, boom swing and auxiliary hydraulics controls are not locked, even when the safety lock lever is set to the lock position. Do not touch these controls accidentally.

CAUTION

Never bring the machine to a sudden stop except in the case of a true emergency. Stop as gently as possible.

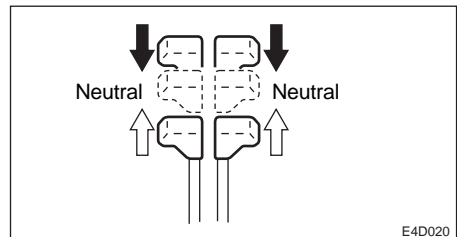

E4D020

1. Slowly set the left and right travel levers to the neutral position. The machine stops.



Operating the Working Equipment

! WARNING

- Be careful to check which pattern of lever control arrangement you are operating with before beginning operations.
- The explanations in this manual are for the ISO pattern.

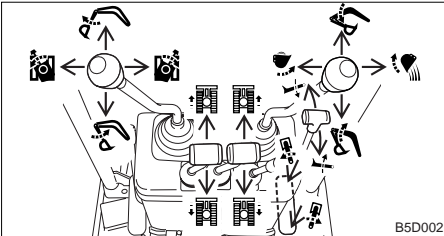

Use the right operating lever to operate the boom and bucket.

Use the left operating lever to operate the arm and for slewing.

Return the operating levers to the neutral position to stop the hoe attachments.

1. Set the safety lock lever to the released position.
2. Set the slew lock lever to the released position.
3. Set the pedals to the level position.

Slewing

! WARNING

Check the surrounding area for safety before slewing.

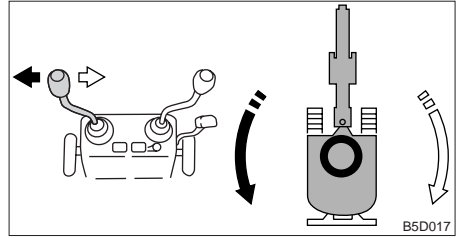

- ➔ To slew left:
Tilt the left operating lever to the left.
- ⇐ To slew right:
Tilt the left operating lever to the right.

Operating the Boom

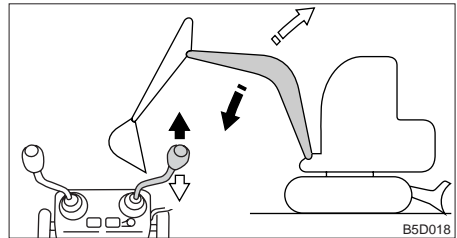

- ➔ To lower the boom:
Tilt the right operating lever forward.
- ⇐ To raise the boom:
Tilt the right operating lever backward.



Operating the Arm

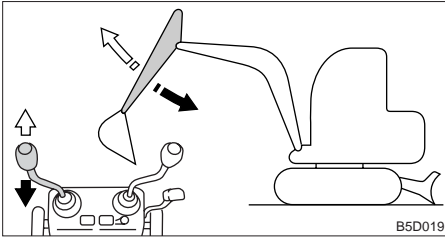

- ➔ To contract the arm:
Tilt the left operating lever backward.
- ⇨ To extend the arm:
Tilt the left operating lever forward.

Operating the Boom Swing

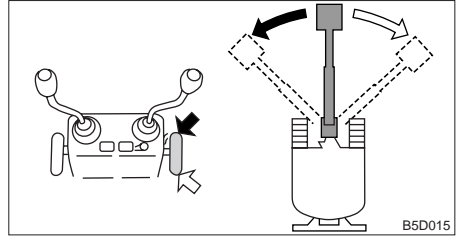

- ➔ To swing left:
Press the toe side of the pedal.
- ⇨ To swing right:
Press the heel side of the pedal.

Operating the Bucket

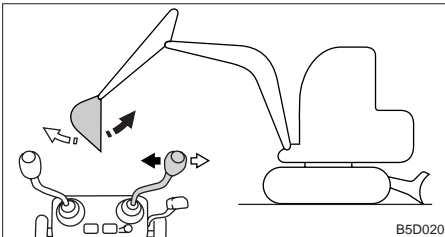

- ➔ To dig:
Tilt the right operating lever to the left.
- ⇨ To dump:
Tilt the right operating lever to the right.

Operating the Dozer Blade

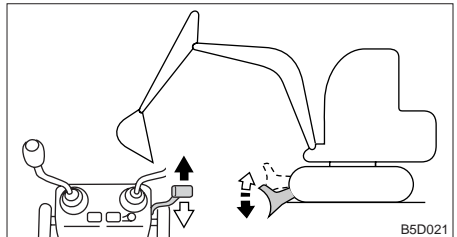

- ➔ To lower the dozer blade:
Tilt the lever forward.
- ⇨ To raise the dozer blade:
Tilt the lever backward.



Operating the Auxiliary Hydraulics

Use this to operate a breaker, crusher or other attachment.

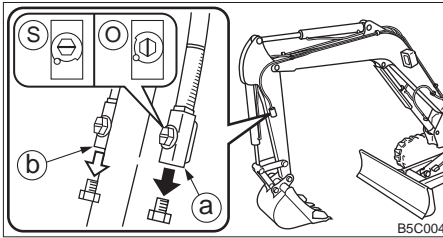
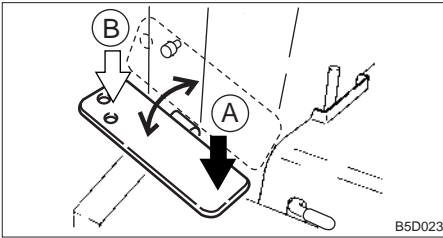

When the pedal is pressed, hydraulic oil is delivered to the auxiliary hose's ports (a) and (b).

- ➔ To deliver hydraulic oil to port (a):
Press the heel side (A) of the pedal.
- ⇨ To deliver hydraulic oil to port (b):
Press the toe side (B) of the pedal.

Refer to page 47 "Auxiliary Hydraulic Lines".



Prohibited Operations

WARNING

- Do not operate on base rock (hard or soft).
- Do not slew (swing) while traveling. If you must operate the hoe attachment while traveling, operate at speeds slow enough so you have complete control at all times.

Do not perform breaking or leveling operations using slew force

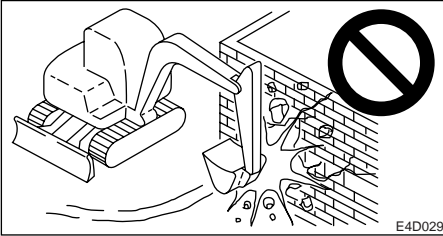

Do not break down walls or level ground using slew force. Also, do not dig the bucket teeth into the ground during slewing. Doing so will damage the hoe attachment.

Do not Dig while Traveling

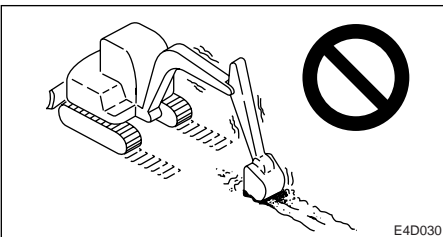

Do not dig the bucket into the ground and use the traveling force to dig.

Be Gentle on the Hydraulic Cylinders

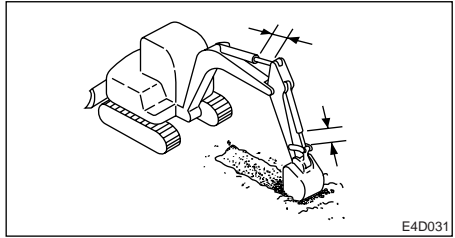

Do not extend the hydraulic cylinders to the stroke ends. Operate them with leeway.

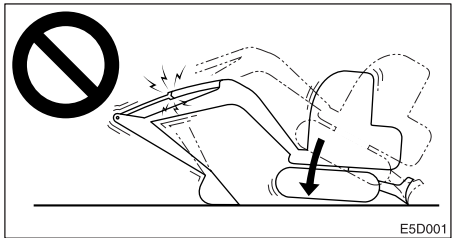

Do not support the machine body with the hoe attachment as it is lowering with the arm cylinder fully extended. Doing so concentrates the load on the arm cylinder and could damage the arm cylinder.

Do not Drive Piles with the Bucket or Dig with it Using Shock Force

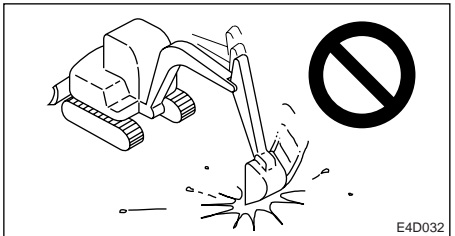

Doing so will shorten the service life of the hoe attachment. Use hydraulic force to dig.



Do not Perform Operations Using the Machine's Dropping Force

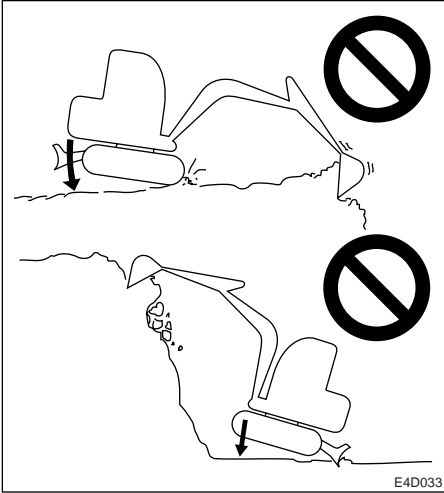

Putting excessive strain on the machine will shorten its service life. Use the hydraulic force of the cylinders and always dig with shallow, long strokes.

Digging Base Rock

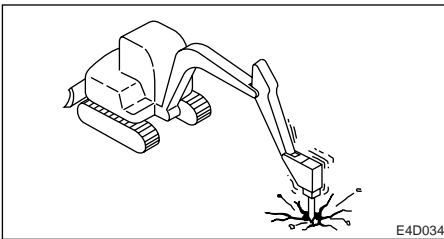

For hard base rock, break the rock up into small pieces with a breaker, etc., before digging. This prevents damage to the machine and is thus more economical in the end.

Caution on Exposing the Dozer Blade to Shocks

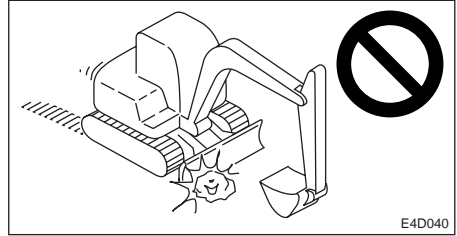

Hitting the dozer blade against rocks, etc., could damage the dozer blade or the blade cylinder.

Caution on Folding the Hoe Attachment

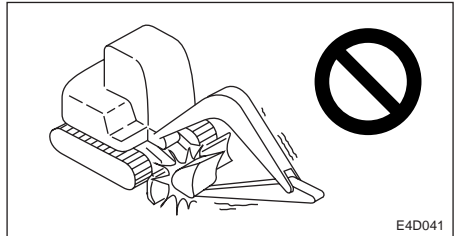

Be careful not to hit the bucket or dozer blade when folding the hoe attachment.

Do not use the Dozer Blade as an Outrigger

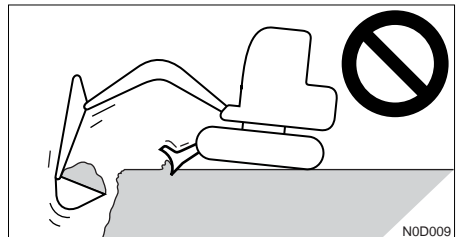

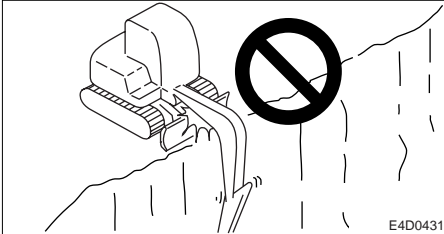
**Pay Attention to the Dozer Blade when Digging**

When digging deeply with the dozer blade positioned at the front, be careful that the boom cylinder and bucket do not hit the dozer blade.

Operate with the dozer blade at the rear whenever possible.

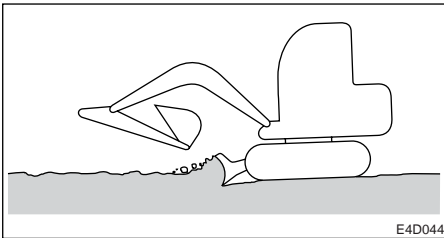
Caution on Digging Down with the Dozer Blade

This dozer blade is designed for simple earth pushing. Do not dig down deeply with the dozer blade. Doing so could damage the dozer blade and lower body.

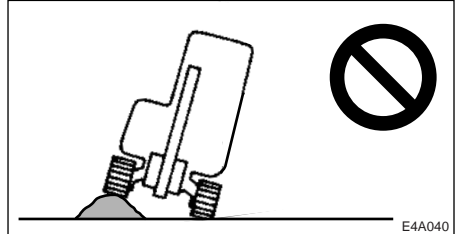
Cautions on Operating**Cautions on Traveling**

Traveling over obstacles (rocks, stumps, etc.) may subject the body to strong shocks and result in damage. Avoid traveling over obstacles whenever possible. If you must do so, keep the hoe attachment near the ground, travel at low speed, and go over the obstacle at the center of the crawler.

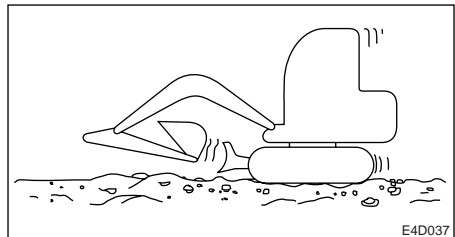
Cautions on Traveling in 2nd (High) Speed

On uneven ground, travel at low speed and avoid accelerating, stopping or changing directions abruptly. Also, when traveling in 2nd speed, do so with the dozer blade at the front.



Cautions on Use in Water

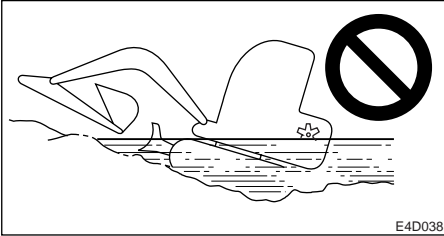

If you leave water at a sharp angle, the rear of the machine may be submerged, exposing the radiator fan to water and damaging them. Do not let the rear of the machine get submerged.

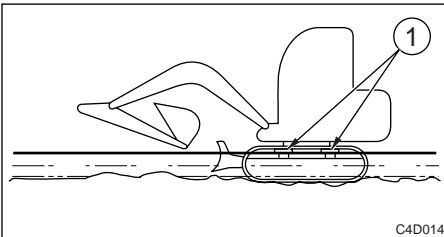

- Allowable water depth

In water, only use the machine up to a depth at which the water comes up to the middle of the shoe slide (1).

- When greasing places used under water for long periods of time, apply enough grease so that the old grease is expelled.
- Never submerge the slew bearing or main body in water or sand. If the slew bearing or main body should get submerged, contact a Takeuchi sales or service outlet for inspection.

Cautions on Traveling on Slopes

WARNING

- Never exceed the machine's stability capabilities (maximum gradeability - 25°, lateral tipping angle - 10°). Also note that when actual working area conditions are poor the machine's stability capabilities may be lower.
- When traveling on slopes or grades, lower the bucket to a height of 20 to 30 cm (8 to 12 in.) off the ground. In emergencies, lower the bucket to the ground and stop the machine.
- When traveling on slopes or grades, move slowly in first gear (low speed).
- Do not travel down slopes in reverse.

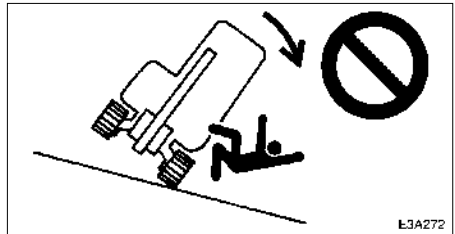

- Do not change directions or cross slopes sideways. First return to a flat surface then redirect the machine.
- On grass, dead leaves, wet metal or frozen surfaces, the machine may slide sideways even on very gentle slopes. Make sure the machine never faces sideways with respect to the slope.



Traveling Posture Traveling up slopes

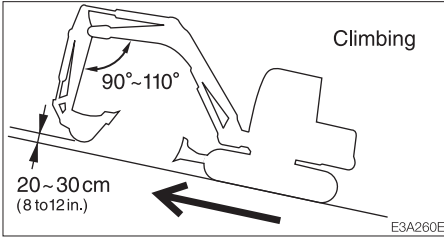

When traveling up slopes at an angle of 15° or greater, travel in the posture shown in the diagram above.

Traveling down slopes

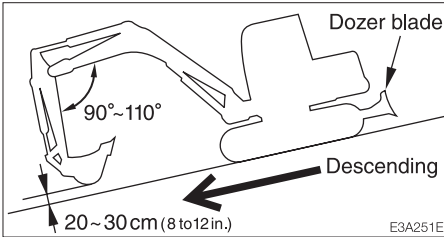

When traveling down slopes at an angle of 15° or greater, lower the engine speed and travel in the posture shown in the diagram above.

Braking when traveling down slopes

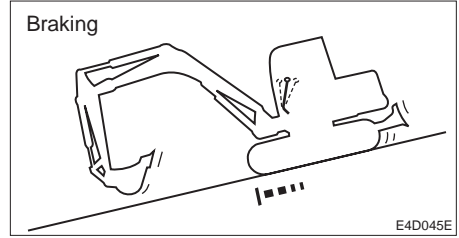

When traveling down slopes, the brakes are applied automatically when the travel levers are returned to the neutral position.

If the crawlers slip

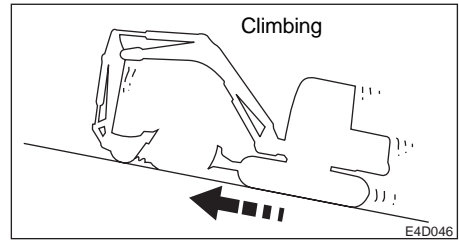

If the crawlers slip while traveling up a slope, use the pulling force of the arm to climb the slope.

If the engine stops

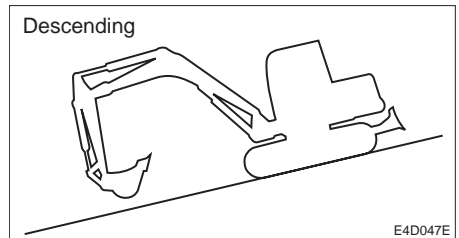

If the engine stops when traveling down a slope, set the travel levers to the neutral position, stop the machine, then start the engine.

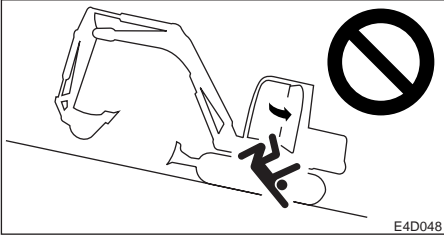
**Do not open the door while traveling on slopes**

Opening the door while traveling on slopes is dangerous, as the force required to open and close the door changes abruptly. Always keep the door closed when traveling on slopes.

Getting Out of Mud

If the machine gets stuck in mud, use the procedure below to get it out.

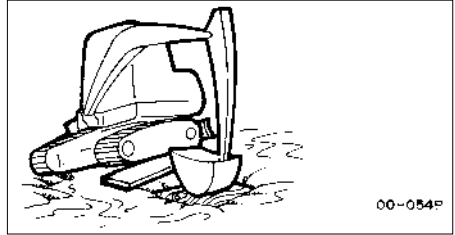
If one crawler is stuck

1. Slew the bucket to the side which is stuck.
2. Set the arm and boom to an angle of 90 to 110°.
3. Press the bottom of the bucket (not the teeth) against the ground.
4. Place a plank, etc., under the lifted crawler.
5. Lift the bucket and slowly move out of the mud.

If both crawlers are stuck

1. Perform steps 1 to 4 above for both crawlers.
2. Dig the bucket into the ground in front of the machine.
3. Pull with the arm and travel forward simultaneously to slowly move out of the mud.

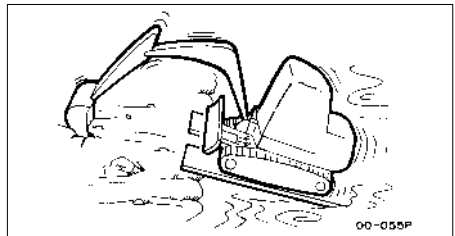



Operations Possible with this Machine

Excavating

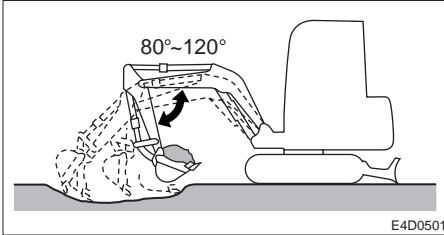

1. Set the dozer blade on the side opposite the side you want to dig on.
2. Use the arm and bucket and dig with shallow, long strokes. The digging force is strongest when the boom and arm angle is 80 to 120°. Use this angle for effective digging.

Digging Ditches

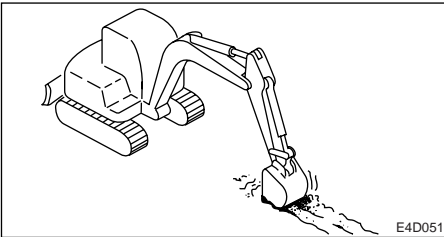

Mount a bucket suited for digging ditches and set the crawlers parallel to the ditch to be dug for greater efficiency.

When digging wide ditches, dig the sides first, the center later.

Digging Side Ditches

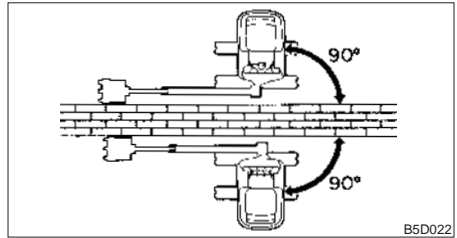

Use the offset function to dig side ditches as shown in the diagram.

Loading

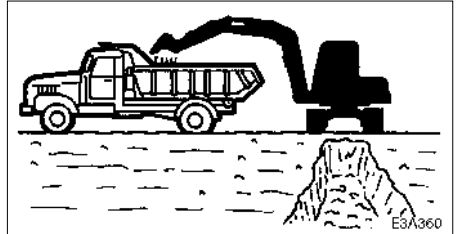

When loading dirt in a truck, starting from the back of the truck's bed makes for easier loading and increases the amount of dirt that can be loaded.

Also, use a small slewing angle for greater efficiency.



Leveling

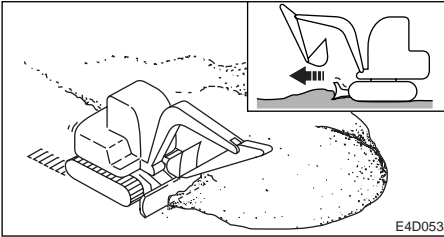

1. Bring the hoe attachment close to the body.
2. Gradually remove the dirt from the side of the mound.
3. Once the mound is low, remove the dirt from the top. If the load on the body is too heavy, adjust by raising or lowering the dozer blade.

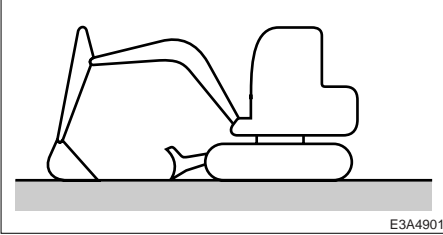
**Parking****⚠ WARNING**

E3A4901

- **Park the machine on firm, level ground and apply the parking device.**
- **Before leaving the operator's seat, raise the safety lock lever to engage the lock and stop the engine. If any controls should be touched accidentally when the safety lock lever is lowered, the machine will move suddenly, and cause serious injury or death.**

1. Set the left and right travel levers to the neutral position.
2. Return the throttle lever and idle the engine at low speed.
3. Set the slew lock lever to the locked position.
4. Lower the bucket and dozer blade to the ground.
5. Raise the safety lock lever to engage the lock.
6. Stop the engine and remove the key.
Refer to page 55 "Stopping the Engine".

Inspection and Checks After Stopping the Engine

1. Check for oil and water leakage and inspect the working equipment, covers and lower body. If any irregularities are found, repair.
2. Fill the fuel tank.
Refer to page 99 "Checking the Fuel Level".
3. Remove any paper scraps or dirt from the engine room.
4. Remove any mud from the lower body.

Locking

Be sure to lock the following places:

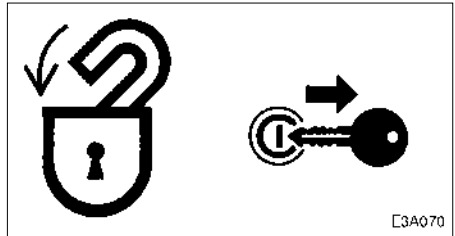

E3A070

- Engine hood



Preparing for Cold Weather

In cold weather, it may be difficult to start the engine and the coolant may freeze. Make the preparations described below.

Changing the Fuel and Lubricant

Change the fuel, hydraulic oil and engine oil to types suited for cold conditions.

Refer to page 88 “Fuel and Lubricant Chart”.

Engine Coolant

WARNING

The coolant is combustible. Keep flames away.

Use long-life coolant (antifreeze) and tap water for the engine coolant.

Supplement: New machines are delivered with JIS Type 2 long-life coolant (antifreeze) at a concentration of 50%.

Refer to page 88 “Fuel and Lubricant Chart”.

Battery

As the temperature drops, the battery performance decreases.

Inspect the battery. If the charge is low, contact a Takeuchi sales or service outlet to have the battery charged.

Refer to page 107 “Inspecting the Battery Fluid Level and Replenishing”.

Cautions after Completing Operations

Heed the following in order to prevent dirt, water, or other objects stuck on the machine as well as the lower body from freezing:

- Remove any dirt or water from the body.
In particular, water droplets on the hydraulic cylinder rod surfaces could freeze, and if dirt enters into the seals along with this, the seals could break.
- Park the machine on a dry, hard surface. If no appropriate place can be found, put boards down and park the machine on them.
- Drain any water from the fuel tank to prevent freezing.
Refer to page 108 “Draining the Fuel Tank”.
- To prevent decreased battery performance, place a cover over the battery or remove it from the machine and store it in a warm place.
Also add battery fluid before starting the next morning. If battery fluid is added after completing operations, the distilled water may not mix, resulting in freezing.

After Cold Weather is Over

Perform the following after cold weather is over:

- Change the fuel and the oils for the different devices with those specified on the Fuel and Lubricant Chart.
Refer to page 88 “Fuel and Lubricant Chart”.
- When using one-season type antifreeze coolant, completely drain the antifreeze coolant, carefully clean the inside of the coolant system, then add tap water.
Refer to page 114 “Cleaning the Engine Cooling System”.



Rubber crawlers have an inherent weakness due to their use of rubber. Be sure to heed the prohibitions and cautions below so as to prevent damage to the crawlers and crawler slippage.

Prohibited Actions

Do not travel or operate the machine in the following places:

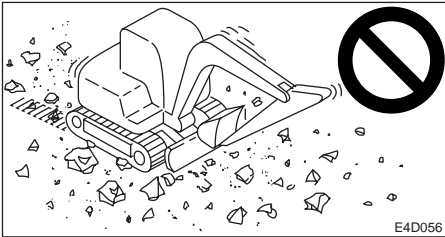

- Traveling or slewing on broken stone, jagged base rock, iron rods, iron scraps or the edges of iron sheets may damage or cut the crawlers.

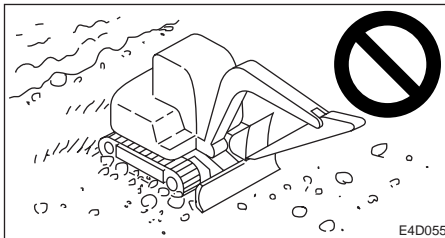

- Traveling on riverbeds or places with many soft rocks may cause the crawlers to slip off or be damaged due to rocks getting stuck in them.
- Do not use on the seashore. The salt may corrode the metal cores.

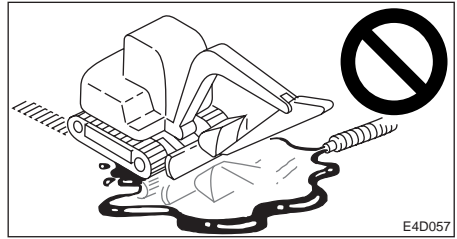

- Do not let fuel, oil, salt or chemical solvents get on the crawlers. These substances may corrode the couplings of the crawlers' metal cores, resulting in rust or peeling. If these substances should get on the crawlers, wipe them off immediately using water.

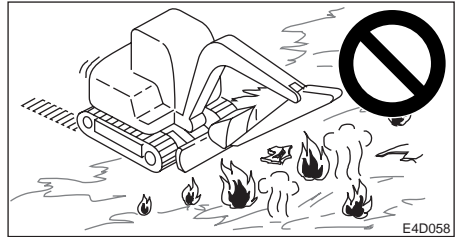

- Traveling on roads directly after asphaltting or on hot surfaces such as over fires or on iron sheets under strong sunlight may result in irregular wear or damage of the lugs.
- Do not move earth in places where the rubber crawlers may slip. Doing so may speed up lug wear.

**Cautions**

Heed the following cautions when operating the machine:

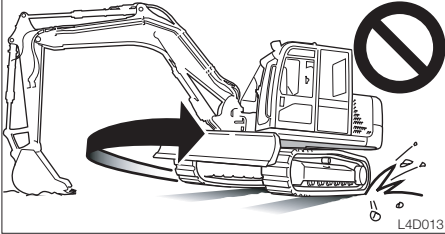

- Do not turn the undercarriage with the front of the machine body lifted using the hoe attachment and the upperstructure left in this posture. Doing so will twist the crawler with the load concentrated on a single point on the crawler belt, rapidly leading to damage.
- Avoid changing course abruptly and spinning on concrete surfaces whenever possible. Doing so may wear or damage the rubber crawlers.
- Avoid drops that may expose the rubber crawlers to strong shocks.
- Salt, potassium chloride, ammonium sulfate, potassium sulfate, and triple superphosphate of lime can damage the crawler belts. If any of these substances should get on the crawler belts, wash them off thoroughly with water.
- Do not let the sides of the rubber crawlers rub against concrete or walls.
- Do not damage the rubber crawlers by hitting the bucket against them.
- Be especially careful in the winter on snowy or frozen surfaces as the crawler belts tend to slip.
- Use rubber crawler belts at temperatures between -25°C to $+55^{\circ}\text{C}$ (-14°F to 131°F).

- When storing the rubber crawlers for long periods of time (3 months or more), do so indoors in a place not exposed to direct sunlight or rain.

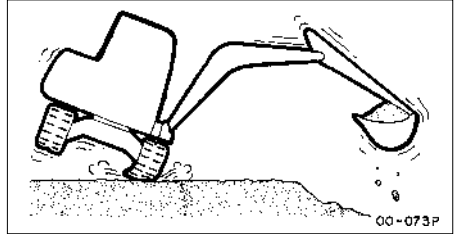

- Rubber crawler belts are not as stable as steel crawler belts since the entire lug is rubber. Be very careful when slewing and swinging sideways.

Preventing the Rubber Crawlers from Slipping Off

Heed the following in order to prevent the rubber crawlers from slipping off:

- Always keep the crawlers at the proper tension.

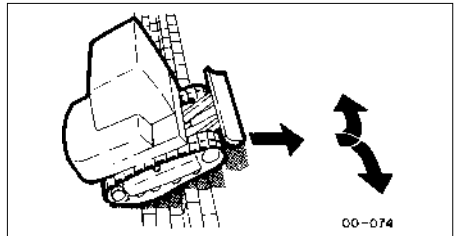

- When traveling up large cobblestone or rock steps (20 cm (8 in.) or greater), climb up the step at a direct angle and do not change course on top of the step.

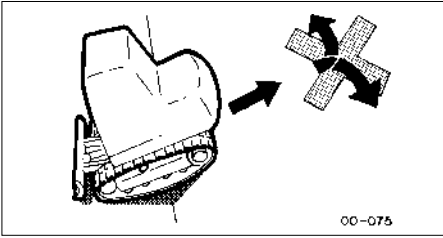

- When climbing in reverse, do not change course at the point where the slope starts.

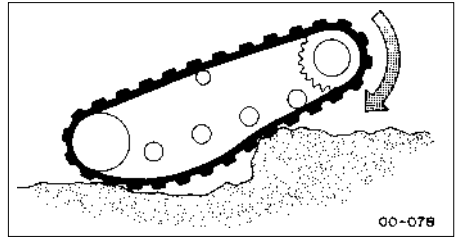
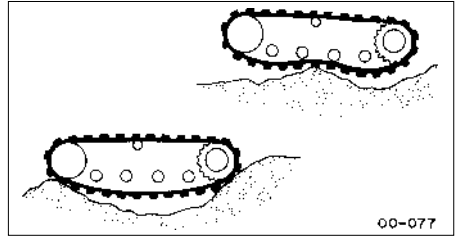

- Do not change directions when the crawler belts are slack as shown in the diagram.

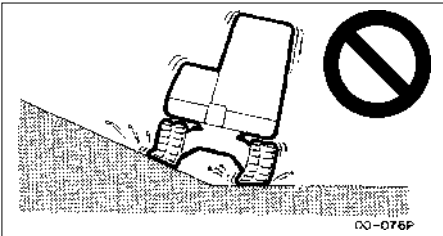

- Avoid traveling with one crawler on a slope or projecting object and the other crawler on a flat surface (with the machine at a tilt of 10° or greater). Travel with both crawlers on flat surfaces.



TRANSPORT

Loading and Unloading	82
Securing the Machine	83
Cautions on Transporting	84

**⚠ WARNING**

The machine may roll or tip over or fall while loading or unloading it. Take the following precautions:

- Select a firm, level surface and keep sufficient distance from road shoulders.
- Use loading ramps of adequate strength and size. Maintain the slope of loading ramps within 15 degrees.
- Keep the truck bed and loading ramps clean of oil, clay, ice, snow, and other materials which can become slippery. Clean the tracks.
- Never change course on the ramp.
- Do not slew (swing) on ramps. The machine may tip over.
- When slewing (swinging) on the truck bed, do so slowly as the footing can be unstable.

When loading or unloading the machine, be sure to use ramps and following the procedure below.

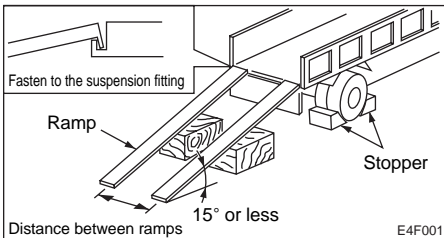

1. Apply the truck's parking brake and place stoppers against its tires.
2. Fasten the ramps securely to the truck bed so that they will not come off. Set the ramps to an angle of 15° or less.
3. Line up the center of the truck bed with the center of the machine and the center of the ramps with the center of the crawlers.
4. Make sure the dozer blade does not hit the ramps.
5. Lower the hoe attachment as much as possible, making sure it will not hit the truck.
6. Lower the engine speed with the throttle lever.

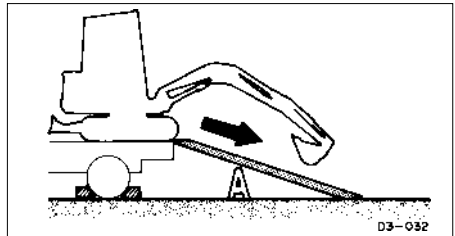
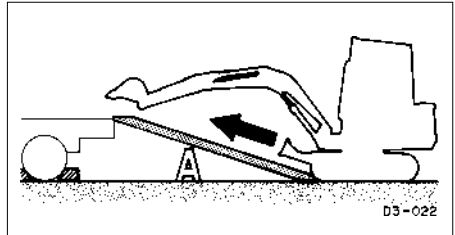

7. Determine the direction on the ramps, then slowly travel up or down the ramps in 1st speed (low speed), following the signals of a flagman.
8. Load the machine properly at the prescribed position on the bed. Refer to page 83 "Transporting Posture".



After loading the machine in the designated position, secure it as described below.

Transporting Posture

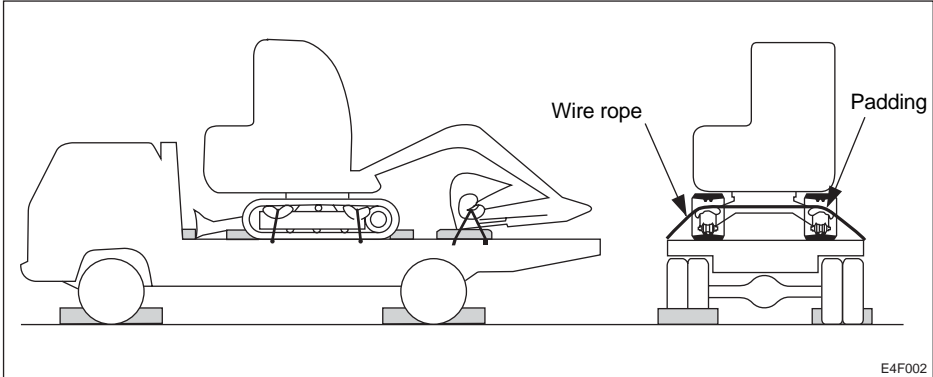

1. Lower the dozer blade.
2. Set the slew lock lever to the locked position.
3. Fully extend the bucket and arm cylinders, then lower the boom.
4. Stop the engine and remove the starter key.
5. Raise the safety lock lever to engage the lock.
6. Set stoppers in front and behind the crawlers.
7. Put a chain or wire rope over the lower frame and fasten it securely to prevent sideways slippage.
8. Secure the bucket with a chain or wire rope.

IMPORTANT: Place a wooden block under the bucket so that it is not damaged by hitting the floor.



WARNING

- **Know and follow the safety rules, vehicle code and traffic laws when transporting the machine.**
 - **Consider the length, width, height and weight of the truck with the machine loaded on it when determining the best route.**
-



MAINTENANCE

General	86
Service Data	88
Important Parts	92
Maintenance Chart	93
Walk-Around Inspection	95
Daily Inspection (Every 10 Hours).....	97
After First 50 Hours (New Machines Only)	102
Every 50 Hours	105
Every 100 Hours	109
After First 250 Hours (New Machines Only)	110
Every 250 Hours	111
Every 500 Hours	113
Every 1000 Hours	114
Every 2000 Hours	117
When Required	119
Long-term Storage	124



Maintenance Description

For long-term use of the machine under good conditions, perform the inspection and maintenance procedures properly and safely as recommended in this manual.

The inspection and maintenance items are divided according to the machine's total operating time (inspection and maintenance to be performed every 10 hours (walk-around and daily inspection), every 50 hours, every 250 hours, etc.). Refer to the hour meter to determine when it is time to perform inspection and maintenance. Items for which it is not possible to determine the inspection and maintenance interval are included under "When Required".

When operating the machine in extremely harsh environments (with high dust levels or high temperatures), inspection and maintenance should be performed earlier than the times indicated on the Maintenance Chart.

Cautions on Maintenance

Do not perform inspection and maintenance procedures not prescribed in this manual. Have inspection and maintenance procedures not prescribed in this manual performed by a Takeuchi sales or service outlet.

Always keep the machine clean.

- Always keep the machine clean, and wash it before performing inspection and maintenance.
- When washing the machine with water, stop the engine and cover the electrical system with plastic to protect it from water. Exposing the electrical system to water is dangerous and could result in short-circuits or malfunction. Do not wash the battery, sensors, connectors or the inside of the cab with water or steam.

Fuel, lubricant and grease

- For fuels, lubricant and grease, follow the instructions on the "Fuel and Lubricant Chart".
- Use pure fuels, lubricants and greases which do not contain water, and be careful to keep dirt out when changing or replenishing fuel, lubricant or grease.
- Store fuels, lubricants and greases in the prescribed places and in such a way that no water or dirt can get in them.

Cautions on fueling

- If the port includes a strainer, do not remove the strainer when fueling.
- After fueling, be sure to securely tighten the cap, etc.
- Do not add more than the prescribed amount of fuel.

**Do not clean parts with fuel.**

Do not use fuel to clean parts. Use a non-combustible cleaning agent.

Keep dirt out.

When mounting and removing parts, do so in a place where there is no dust, clean the working area and the part, and keep dirt out.

Clean mounting surfaces.

When mounting and removing parts, be sure that the surfaces of contact of the parts are clean. If the sealing grooves of the surface of contact are damaged, consult a Takeuchi sales or service outlet.

Seals and split pins

- Replace removed seals and split pins with new ones.
- When mounting, be careful not to damage or twist the seal.

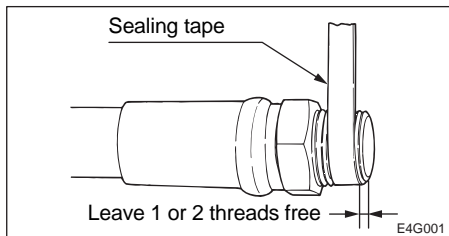
Sealing tape

- When wrapping sealing tape around plugs, etc., remove any old sealing tape from the threads and clean the threads.
- Wrap the sealing tape tight, leaving 1 or 2 threads at the tip free.

Disposing of wastes

- Collect spent fluids from the machine in containers. Disposing of wastes irresponsibly damages the environment.
- Dispose of oil, fuel, cooling water, coolant, filters, batteries and other harmful substances as prescribed by law.

Check after maintenance

- Gradually increase the engine speed from a low idle to maximum speed and check that there is no oil or water leaking from serviced parts.
- Operate all the operating levers and check that the machine is operating properly.

Cautions on handling of battery cables

- Disconnect the battery cables (+,-) before working on the electrical system or doing any welding.
Remove the negative (-) battery cable first. When reconnecting the battery, connect the negative (-) battery cable last.
- Do not disconnect the battery cables while the engine is running. Doing so could damage the electronic circuitry of the alternator and other parts.



Fuel and Lubricant Chart

Use different fuels, lubricants and greases according to the temperature, referring to the chart below.

- Change the lubricant earlier than as shown in the table if it is extremely dirty or its performance has deteriorated severely.
- Whenever possible, use the same brand of lubricant as before. If changing with a different brand, replace the entire quantity – do not mix different brands.

Part	Type	Type by temperature										Replacement interval	Capacity ℓ (US. qt.)				
		-22	-4	14	32	50	68	86	104	°F	-30			-20	-10	0	10
Engine oil pan	Diesel engine oil API - CD	SAE 5W-20										After first 50 hrs. Every 250 hrs.	Upper limit: 1.7 (1.8) Lower limit: 1.0 (1.1)				
		SAE 10W-30															
		SAE 15W-40															
Hydraulic tank	Antiwear hydraulic oil	ISO VG32										Every 2000 hrs.	System: 14 (3.7 U.S.gal) Tank: 7.3 (1.9 U.S.gal)				
		ISO VG46															
		ISO VG68															
Fuel tank	Diesel fuel	Use a clean, Quality fuel for good performance and optimum engine life. • To prevent fuel flow problems in cold weather, use diesel fuel with a pour point of at least -12°C (10°F) below the lowest expected ambient temperature. • Minimum cetane number is 45. Low temperature or high altitude operation may require the use of fuel with a higher cetane number.										Tank: 8 (2.1 U.S.gal)					
Engine cooling system	Coolant (water * + coolant **)	50% coolant mixture										Every 1000 hrs.	2.8 (3.0)				
		30% coolant mixture															
Travel reduction gear	Gear oil API-GL-4	SAE 90										After first 250 hrs. Every 1000 hrs.	0.33 (0.35) each				
Slew motor pinion	Lithium based grease EP-2 NLGI No. 2											Every 50 hrs.	As required				
Slew bearing												Every 50 hrs.					
Working equipment												Daily or every 10 hrs.					
Levers												When required					

* For water, use tap water (soft). Do not use well or river water.

** When the ambient temperature drops below 0°C, add coolant (antifreeze). Follow the coolant manufacturer's instructions to determine the mixture ratio.

**Replace the hydraulic oil regularly!**

- When using a hydraulic breaker, the oil deteriorates quicker than during normal digging. Be sure to replace the hydraulic oil and return filter element.
 - Failure to replace these in time can lead to damage to the machine and breaker's hydraulic systems. In order to improve the service life of the hydraulic systems, be sure to replace the hydraulic oil and return filter element after the number of hours shown on the diagram below.
 - Clean the suction strainer when changing the return filter element.

Replacement Interval (Hours)

Item	Hydraulic Oil	Filter Element
1st time	—	25
2nd time	—	100
Periodically	600	200

When the breaker operating ratio is 100%
Refer to page 154 "Hydraulic Breaker".

Expendables

Replace expendables such as filters and elements periodically, referring to the table below.

Item	Part name	Part No.	Replacement interval
Return filter	Cartridge	15510-20310	After first 50 hrs. Every 500 hrs.
Fuel filter	Element	119810-55650	Every 500 hrs.
Engine oil filter	Cartridge	119305-35151	After first 50 hrs. Every 250 hrs.
Air cleaner	Element (outer)	119655-12560	Every 1000 hrs. or after 6 cleanings (whichever comes first)
	Inner Element (option)	19111-01342	Every 1000 hrs. or after 3 cleanings of the outer element (whichever comes first)



Tools

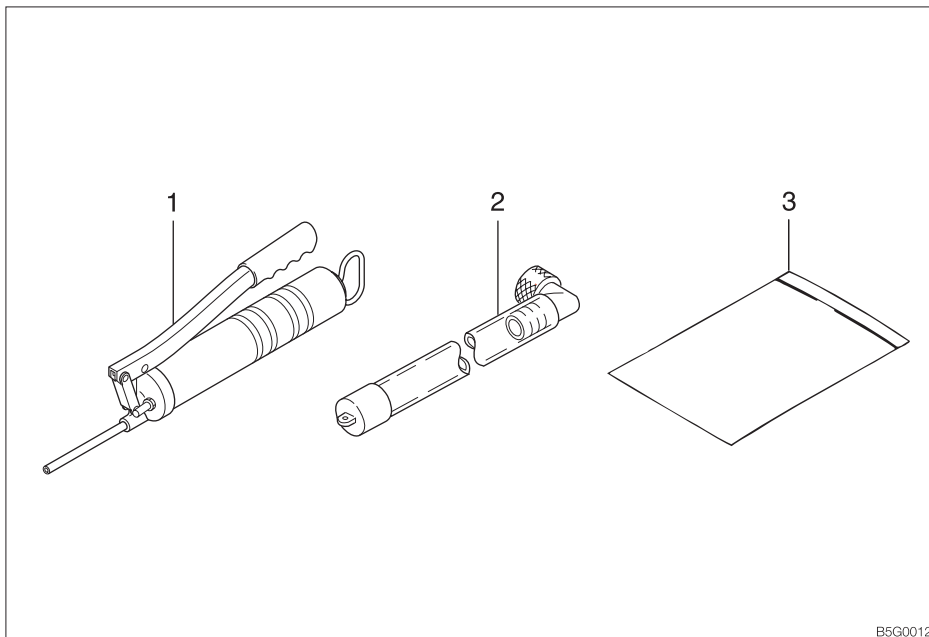

B5G0012

No.	Part name	Part No.	Remarks
1	Grease gun	16910-60600	600cc
2	Drain connector	15545-12201	
3	Case	16919-00001	



Tightening Torques

Nuts and Bolts (for ISO strength category 10.9)

Tighten nuts and bolts at the torques shown on the table below, unless otherwise specified in the text.

- Tightening torques when mounting plastic covers differ from the values on the table below. Consult a Takeuchi sales or service outlet. Tightening too strongly will break the cover.
- When replacing nuts and bolts, replace them with nuts and bolts of the same size and standards.
- Tighten nuts and bolts alternately (top, bottom, left then right) or in 2 or 3 times so that they are tightened uniformly.

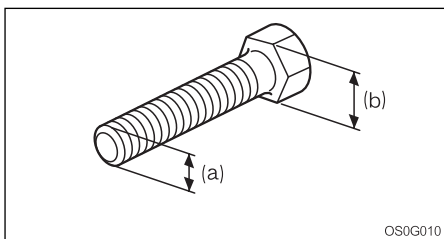
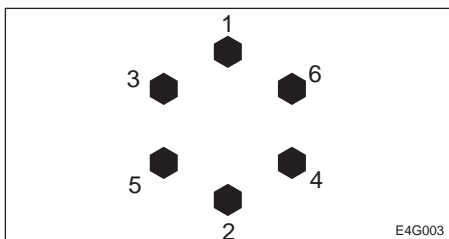

Thread	Head width (b)	Size (a) X Pitch	Torque	
			General Connection Points	
	mm	mm	N·m	ft·lb
Coarse	10	M6 X 1.0	9.8 ± 0.5	7.2 ± 0.4
	12, 13	M8 X 1.25	22.6 ± 1.1	16.6 ± 0.8
	14, 17	M10 X 1.5	47.1 ± 2.4	34.7 ± 1.7
	17, 19	M12 X 1.75	83.4 ± 4.1	61.5 ± 3.0
	19, 22	M14 X 2.0	134.4 ± 6.7	99.1 ± 4.9
	22, 24	M16 X 2.0	207.9 ± 10.4	153.3 ± 7.7
Fine	27, 30	M20 X 2.5	410.9 ± 20.5	303.1 ± 15.1
	12, 13	M8 X 1.0	24.5 ± 1.2	18.1 ± 0.9
	14, 17	M10 X 1.25	50 ± 2.5	36.9 ± 1.8
	17, 19	M12 X 1.5	87.3 ± 4.3	64.4 ± 3.2
	19, 22	M14 X 1.5	135.3 ± 6.8	99.8 ± 5.0
	22, 24	M16 X 1.5	220.6 ± 11	162.7 ± 8.1
	27, 30	M20 X 1.5	452.1 ± 22.6	333.4 ± 16.6



For safe use, the machine must be serviced periodically. To increase safety, periodically replace the parts listed in the following table of important parts.
Serious injury or a fire could result if they deteriorate or are damaged.

Table of Important Parts

Unit		Important parts to be replaced periodically	Replacement Interval
Fuel system		Fuel hoses	Every 2 years
		Packing in fuel filler cap	
Hydraulic system	Main body	Hydraulic hoses (Pump - delivery)	
		Hydraulic hoses (Pump - suction)	
		Hydraulic hoses (Slew motor)	
		Hydraulic hoses (Travel motor)	
	Working equipment	Hydraulic hoses (Boom cylinder lines)	
		Hydraulic hoses (Arm cylinder lines)	
		Hydraulic hoses (Bucket cylinder lines)	
		Hydraulic hoses (Swing cylinder)	
		Hydraulic hoses (Blade cylinder)	
		Hydraulic hoses (Spanner cylinder)	
		Hydraulic hoses (Auxiliary lines)	

Above important parts are vulnerable to aging and wear or deterioration and it is difficult to determine the degree to which they have deteriorated on the occasion of periodic service. To maintain their proper function at all times, therefore, replace them with new ones after using them for a specific period of time even if no abnormality is found with the parts. If you find abnormalities in these parts before their scheduled replacement time is reached, repair or replace them immediately. If a hose clamp is deformed or cracked, replace it immediately. When replacing the important parts, please contact a Takeuchi sales or service outlet .

Also check the hydraulic hoses other than the above important parts. If any abnormality is found in them, retighten them or replace them immediately.

When replacing the hydraulic hoses, replace the O-rings and seals at the same time.

Check the fuel and hydraulic hoses according to the periodic schedule described below. Refer to "Maintenance".

Type of inspection	Inspection item
Daily inspection	Leakages from joints, hydraulic or fuel hoses.
Monthly inspection	Leakages from joints, hydraulic or fuel hoses.
	Damaged hydraulic or fuel hoses(cracks, wear and tear).
Annual inspection	Leakages from joints, hydraulic or fuel hoses.
	Deteriorated, twisted, damaged hydraulic or fuel hoses (cracks, wear and tear) or hoses in contact with other parts of the machine.



Maintenance Items	See page
Walk-Around Inspection	
Inspecting by opening the engine hood	95
Inspecting by walking around the machine	96
Inspecting while sitting in the operator's seat	96
Daily Inspection (Every 10 Hours)	
Inspecting and replenishing the coolant	97
Inspecting and replenishing the engine oil	98
Inspecting the water separator	99
Checking the fuel level	99
Inspecting the hydraulic oil level and replenishing	100
Lubricating the working equipment	101
After First 50 Hours (New Machines Only)	
Replacing the hydraulic oil return filter	102
Replacing the engine oil and oil filter	103
Inspecting and adjusting the fan belt	104
Every 50 Hours	
Inspecting and adjusting the crawler tension	105
Lubricating the slew bearing	106
Lubricating the slew motor pinion	107
Inspecting the battery fluid level and replenishing	107
Draining the fuel tank	108
Every 100 Hours	
Cleaning the fuel filter	109
Cleaning the water separator	109
After First 250 Hours (New Machines Only)	
Replacing the travel motor gear oil	110



Maintenance Items	See page
Every 250 Hours	
Cleaning the air cleaner	111
Cleaning the radiator fins	112
Replacing the engine oil and oil filter	112
Inspecting and adjusting the fan belt	112
Every 500 Hours	
Replacing the fuel filter	113
Replacing the hydraulic oil return filter	113
Every 1000 Hours	
Cleaning the engine cooling system	114
Replacing the air cleaner element	115
Replacing the travel motor gear oil	116
Inspecting and adjusting the engine valve clearance	116
Retightening the engine cylinder head bolts	116
Inspecting the engine fuel injection pressure and spray condition	116
Every 2000 Hours	
Replacing the hydraulic oil and cleaning the suction strainer	117
Inspecting the engine fuel injection timing	118
Inspecting the engine fuel injection valve	118
When Required	
Replacing the bucket	119
Inspecting the rubber crawlers	121
Replacing the rubber crawlers	122



Perform the following inspections once every day before starting the engine the first time.

⚠ WARNING

- Before operating, perform the walk-around inspections and make repairs immediately should any irregularities be found.
- Be sure to secure the engine hood when opening it. Do not open the engine hood on slopes or in strong wind.

Before starting the engine, look around the machine and lower body, clean any combustible materials off high temperature parts of the engine, and inspect for such irregularities as oil leakage, water leakage and looseness of nuts and bolts.

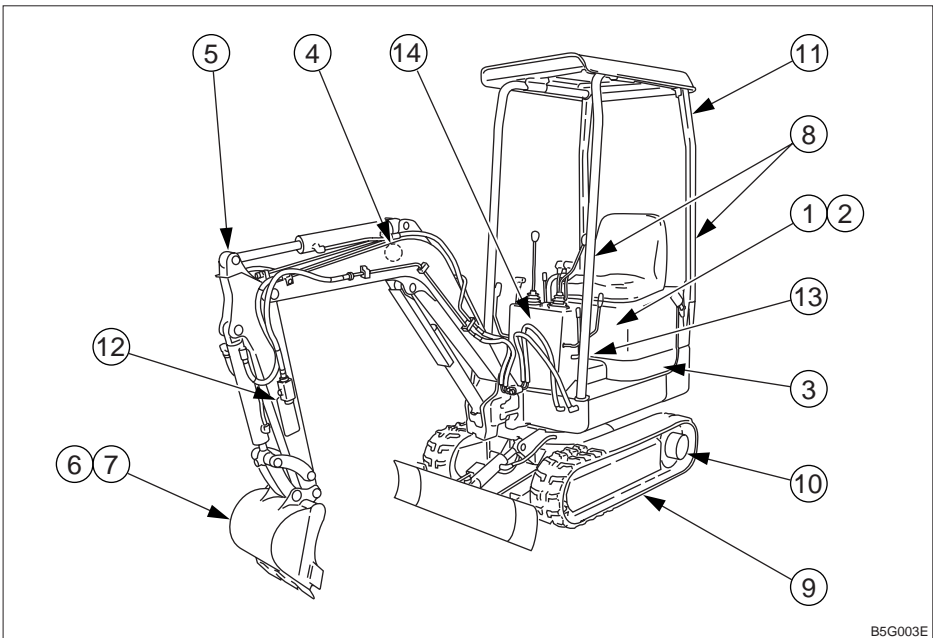

B5G003E

Inspecting by Opening the Engine Hood

1. Check for any twigs, leaves, oil or other combustible materials around the engine and battery.
2. Check for oil or engine coolant water leakage around the engine.
3. Check for oil leakage from the hydraulic tank, hydraulic devices, hoses and connections.

**Inspecting by Walking Around the Machine**

4. Check lights for dirt, damage and burnt out bulbs.
5. Check attachments and hoses for damage.
6. Check the bucket, bucket teeth and side cutter for wear, damage and looseness.
7. Check the hook, slip stopper and hook mount of buckets with hooks for damage. (Option)
8. Check the handrail and step for damage and loose bolts.
9. Check the crawler, shoe slide, track roller, idler and sprocket for damage, wear and loose bolts.
10. Check for oil leakage from the travel motor.
11. Check the canopy, cab and guard for damage and loose nuts and bolts.
12. Check the labels for dirt and damage.

Inspecting While Sitting in the Operator's Seat

13. Check the operator's seat for dirt, oil or other combustible materials.
14. Check the monitor, instruments and switches for dirt or damage.



Perform the following inspections once every day before starting the engine the first time.

⚠ WARNING

- Before operating, perform the Daily inspections and make repairs immediately should any irregularities be found.
- Be sure to secure the engine hood when opening it. Do not open the engine hood on slopes or in strong wind.

Inspecting and Replenishing the Coolant**⚠ WARNING**

Do not remove the radiator cap or drain plugs when the coolant is hot. Stop the engine, let the engine and radiator cool and loosen the radiator cap or drain plugs slowly.

Replenishing

1. Add coolant to a level of 30 mm (1.2 in.) above the top surface of the radiator core.
2. Install the radiator cap (1).

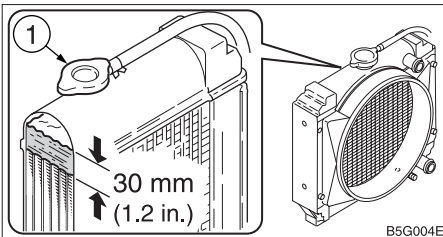
Inspection

1. Open the engine hood.
2. Place a cloth over the radiator cap (1) and loosen it gradually to release the internal pressure before removing it.
3. Inspect the coolant level in the radiator.
 - The coolant level must be 30 mm (1.2 in.) above the top surface of the radiator core.
 - If the coolant level is low, add coolant.



Inspecting and Replenishing the Engine Oil

⚠ WARNING

Stop the engine and allow the machine to cool down before performing inspection and maintenance.

Inspection

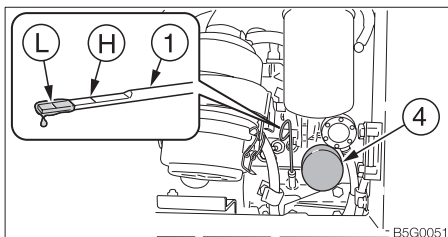

1. Open the engine hood.
2. Pull out the dipstick (1) and wipe off the oil with a rag.
3. Fully reinsert the dipstick (1), then pull it back out.
4. Check the oil on the dipstick (1).
The level must be between the upper limit (H) and lower limit (L).
If it is below the lower limit (L), replenish.

Replenishing

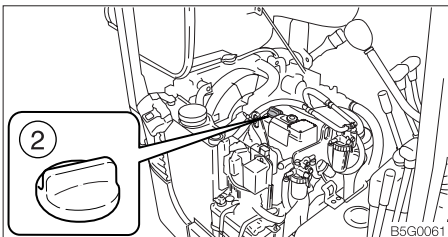

1. Remove the oil supply cap (2).
2. Add oil up to the upper limit (H) of the dipstick (1).
Problems could arise if the oil level is either too low or too high.

3. Tighten the oil supply cap (2).
4. Start the engine, run it at low idle for about 3 minutes, then stop it.
5. After about 10 minutes, inspect the oil level.



Inspecting the Water Separator

WARNING

Stop the engine and allow the machine to cool down before performing inspection and maintenance.

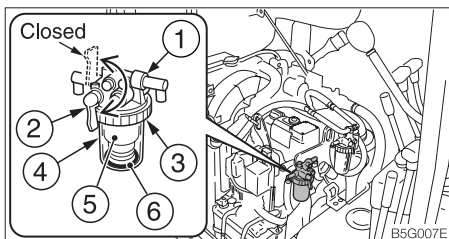

1. Open the engine hood.
2. Inspect the water separator (1).

If the red indicator ring (6) is sunk to the bottom of the case (4), no water is mixed in.

If the red indicator ring (6) is floating, there is water up to the bottom of the ring. Drain the water and clean.

Refer to page 109 "Cleaning the Water Separator".

Checking the Fuel Level

WARNING

- Do not smoke or permit open flames while fueling or near fueling operations.
- Stop the engine in a well-ventilated place when adding fuel.
- Clean up spilled fuel immediately.
- Do not fill the fuel tank to capacity. Allow room for expansion.
- Tighten the fuel filler cap securely.

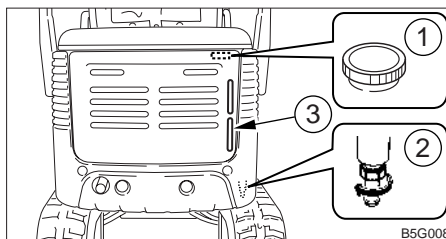

1. Check the fuel level using the sight gauge (3).
2. If the level is low, add fuel from the fuel port (1) while watching the sight gauge (3). Refer to page 39 "Fuel Filler Cap".



Inspecting the Hydraulic Oil Level and Replenishing

⚠ WARNING

Oil may spurt out if caps or filters are removed or pipes disconnected before releasing the pressure in the hydraulic system.

- Gradually loosen the vent plug to relieve tank pressure.

Inspection

The oil level changes according to the oil temperature. Inspect the oil level in the hydraulic oil level inspection posture shown in the diagram.

- Hydraulic oil level inspection posture

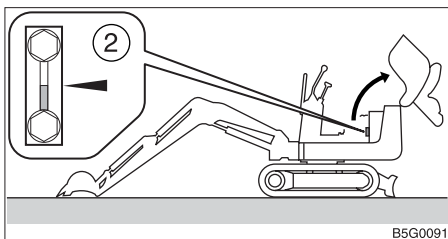

1. Start the engine and run it at low speed.
2. Fully retract the arm and bucket cylinders and ground the bucket.
3. Ground the dozer blade, then stop the engine.
4. Open the engine hood.
5. Inspect the oil level using the sight gauge (2).

- When the oil temperature is about 20°C (68°F):

The level should be at the middle of the sight gauge.

If it is below the middle, replenish.

Replenishing

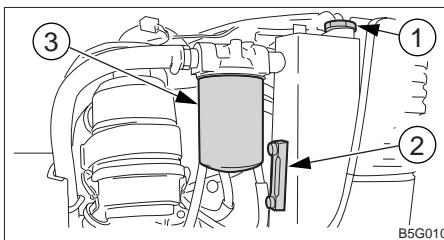

1. Slowly turn the vent plug (1) to release the internal pressure, then remove.
2. Add hydraulic oil up to the middle of the sight gauge (2).
3. Pressurize the hydraulic tank using the procedure next.

Pressurizing the hydraulic tank

1. Start the engine and run it at low speed.
2. With the vent plug (1) removed, set the safety lock lever to the released position.

- Hydraulic tank pressurization posture

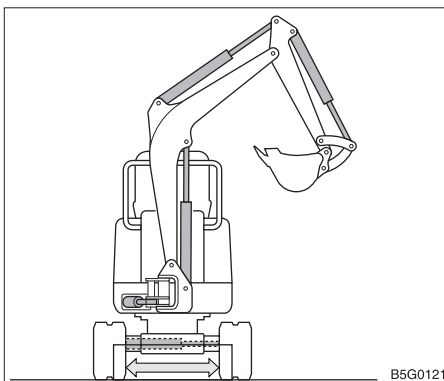

3. Fully extend the bucket, arm, boom and swing cylinders.
4. Stop the engine and set the safety lock lever to the locked position.
5. Tighten the vent plug (1).



Lubricating the Working Equipment

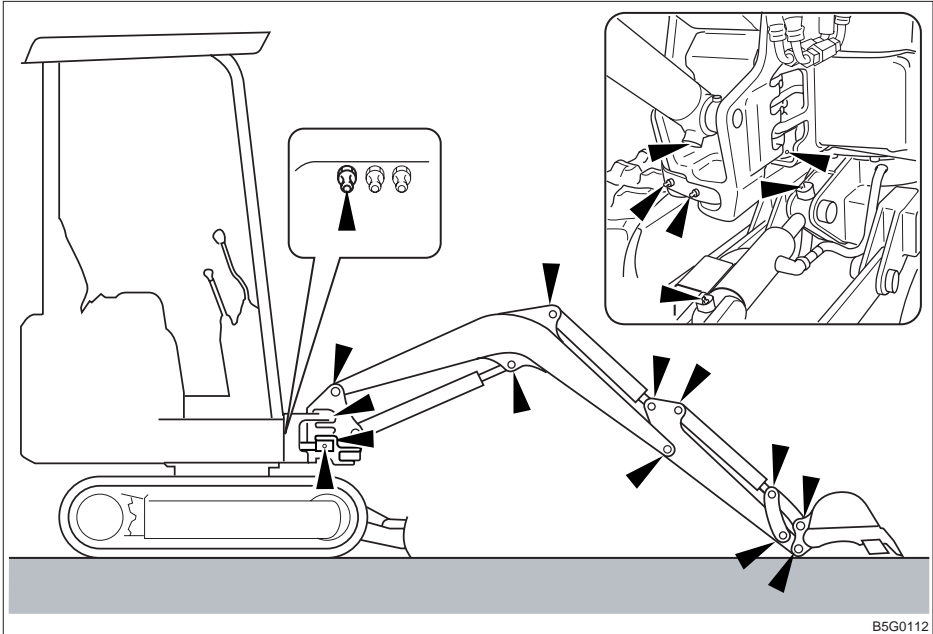

B5G0112

1. Set the machine to the lubrication posture shown in the diagram above, ground the working equipment, then stop the engine.
2. Use the grease gun to lubricate the grease nipples.
3. Wipe off the expelled grease.



Replacing the Hydraulic Oil Return Filter

WARNING

- **Stop the engine and allow the machine to cool down before performing maintenance.**
- **The engine, hydraulic lines and many other parts of the machine are hot directly after the engine is stopped. Touching these parts will cause burns.**
- **The hydraulic fluid is also hot and under high pressure. Be careful when loosening caps and plugs. Working on the machine under these conditions could result in burns or injuries due to the hot oil spurting out.**
- **Oil may spurt out if caps or filters are removed or pipes disconnected before releasing the pressure in the hydraulic system.**
 - **Gradually loosen the vent plug to relieve tank pressure.**
 - **When removing plugs or screws or disconnecting hoses, stand to the side and loosen slowly to gradually release the internal pressure before removing.**

3. Using a filter wrench, turn the filter (3) counterclockwise and remove it.
4. Clean the surface of installation of the filter stand.
5. Apply a thin layer of oil to the packing of the new filter.
6. Install the new filter by hand.
7. Tighten 3/4 more turns with the filter wrench after the filter packing comes in contact with the surface of installation.
8. Inspect the level with the sight gauge (2), and replenish if the level is low. Refer to page 100 "Inspecting the Hydraulic Oil Level and Replenishing".
9. Pressurize the hydraulic tank. Refer to page 100 "Pressurizing the Hydraulic Tank".

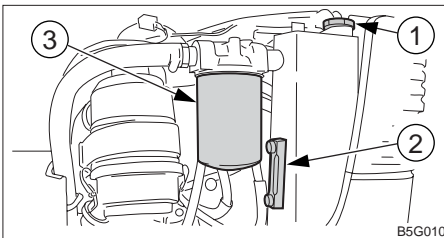

B5G010

1. Open the engine hood.
2. Slowly turn the vent plug (1) to relieve tank pressure, then remove.



Replacing the Engine Oil and Oil Filter

WARNING

Stop the engine and allow the machine to cool down before performing maintenance.

- The engine, muffler, radiator and many other parts of the machine are hot directly after the engine is stopped. Touching these parts will cause burns.
- The engine oil is also hot. Be careful when loosening caps and plugs. Working on the machine under these conditions could result in burns.

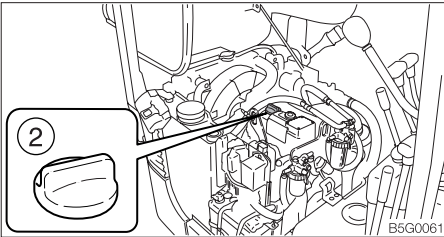

1. Open the engine hood.
2. Remove the oil supply cap (2).

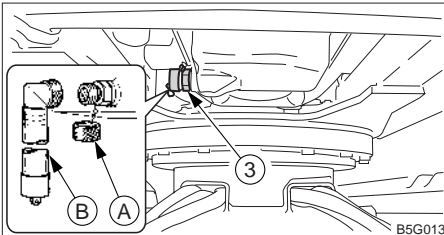

3. Place a pan for catching the spent oil under the drain plug (3).

4. Remove cap (A), install connector (B) and drain the oil. (The oil comes out when the screw is tightened.)
5. Remove connector (B) and install cap (A).

IMPORTANT: Check the spent oil. If it contains large amounts of metal powder, consult a Takeuchi sales or service outlet.

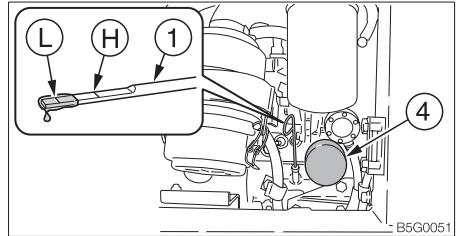

6. Using a filter wrench, turn the filter (4) counterclockwise and remove it.
7. Clean the surface of installation of the filter stand.
8. Apply a thin layer of oil to the packing of the new filter.
9. Install the new filter by hand.
10. Tighten 3/4 more turns with the filter wrench after the filter packing comes in contact with the surface of installation.
11. Add oil up to the upper limit (H) of the dipstick (1). Problems could arise if the oil level is either too low or too high.
12. Tighten the oil supply cap (2).
13. Start the engine, run it at low idle for about 3 minutes, then stop it.
14. After about 10 minutes, inspect the oil level.



Inspecting and Adjusting the Fan Belt

WARNING

Stop the engine and allow the machine to cool down before performing inspection and maintenance.

- The engine, muffler, radiator, hydraulic lines, sliding parts and many other parts of the machine are hot directly after the engine is stopped. Touching these parts will cause burns.

Inspection

1. Open the engine hood.

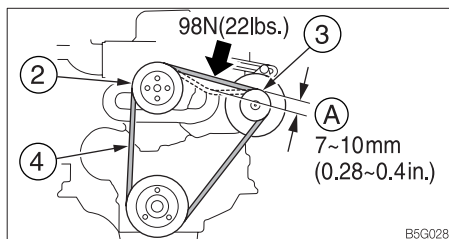

2. Press at the center of the fan pulley (2) and alternator pulley (3) and check the tension (about 98N or 22 lbs.).
The slack (A) should be about 7 to 10 mm (0.28 to 0.4 in.).
3. Inspect the fan belt (4) and replace it if:
 - there are cuts or cracks.
 - the belt is worn and touches the bottom of the V groove in the pulley.
 - the belt stretches and cannot be adjusted.

Adjustment

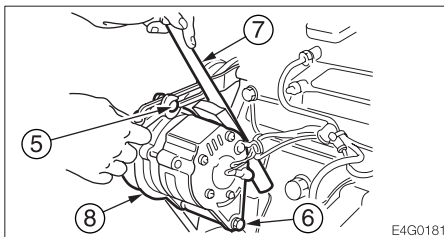

1. Loosen the adjustment bolt (5) and locking nut (6).
2. Using a lever (7), move the alternator (8) and adjust the slack.
3. Tighten the adjustment bolt (5) and locking nut (6).



Inspecting and Adjusting the Crawler Tension

⚠ WARNING

- If you must work beneath the raised machine or equipment, always use wood blocks, jack-stands or other rigid and stable supports. Never get under the machine or working equipment if they are not sufficiently supported. This procedure is especially important when working on hydraulic cylinders.
- The track adjuster contains highly pressurized grease. If the tension is adjusted without following the prescribed procedure, the grease discharge valve may fly off, resulting in injury.
 - Do not loosen the grease nipple.
 - Loosen the grease discharge valve slowly.
 - Do not put your face, arms, legs or body in front of the grease discharge valve.
 - If no grease is expelled when grease discharge valve is loosened, there is a problem. Contact your nearest service outlet for repairs. DO NOT disassemble, as this is very dangerous.

Inspection

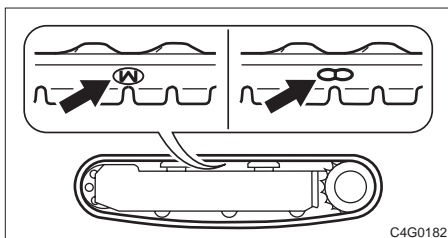

1. For rubber crawlers, move the machine so that the "M" or "∞" mark at the coupling is at the top center of the crawler frame.

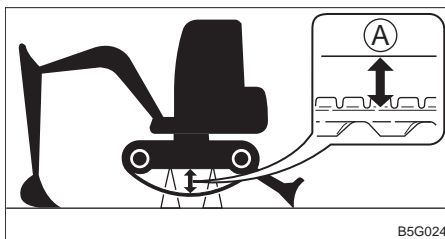

2. Use the operating devices to lift the body. Operate the levers slowly.

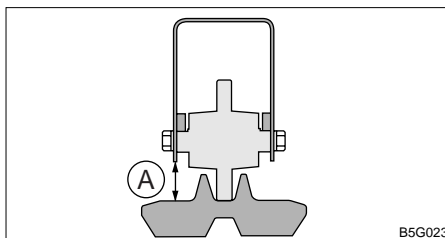

3. Inspect the gap (A) between the bottom surface of the frame at the center of the crawler frame and the top surface of the crawler. The gap (A) should be within the following range:
 - (A) Rubber crawler :
53 to 58 mm (2.1 to 2.3 in.)

Adjustment

Increasing the tension

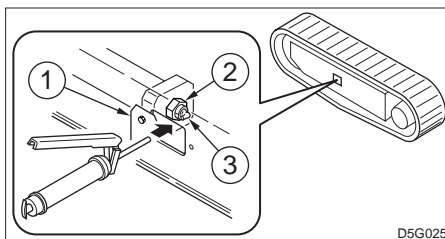

1. Remove the cover (1).
2. Using the grease gun, insert grease through the grease nipple (3) in the grease discharge valve (2).
3. Inspect the crawler tension.



Decreasing the tension

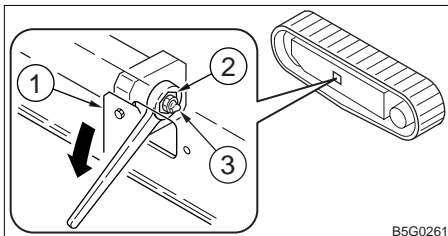

1. Remove the cover (1).
2. Using the Spanner, slowly loosen the grease discharge valve (2) and drain the grease.

If the grease does not drain easily, move the machine forward or backward.

3. Tighten the grease discharge valve (2).
 - Tightening torque: 177 N·m (130 ft.lb.)

Lubricating the Slew Bearing

⚠ WARNING

Do not slew while lubricating. Doing so is dangerous, as you may get caught in the machine.

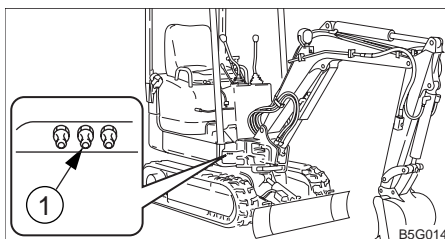

1. Stop the engine with the machine in the posture shown on the diagram above.
2. Use the grease gun to supply grease to the grease nipple (1).

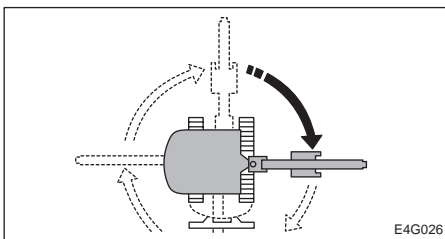

3. Start the engine, lift the bucket and slew clockwise 90°.
4. Ground the bucket and stop the engine.
5. Repeat steps 2 to 4 above three times.
6. Wipe off the grease expelled from the slew bearing and grease nipple.



Lubricating the Slew Motor Pinion

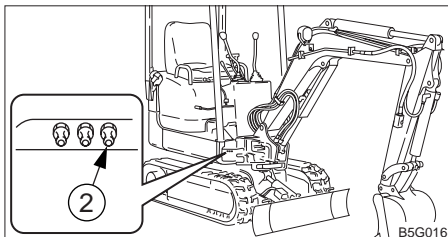

1. Stop the engine with the machine in the posture shown on the diagram above.
2. Use the grease gun to supply grease to the grease nipple (2).
3. Wipe off the grease expelled from the grease nipple.

Inspecting the Battery Fluid Level and Replenishing

DANGER

- Do not use the battery when the fluid level is below the lower level. Doing so will hasten the deterioration of the internal portions of the battery and shorten the battery life, and can also cause rupturing (or an explosion).
- Batteries generate flammable and explosive gases. Keep arcs, sparks, flames and lighted tobacco away.
- Use a dampened cloth to clean the area of the fluid level lines and check the fluid level. Note that if this area is cleaned with a dry cloth, static electricity could cause ignition or explosion.

WARNING

- Do not fill the battery above the upper level. Doing so could cause the fluid to leak, contact and damage the skin, or cause parts to corrode.
- Batteries contain sulfuric acid which will damage eyes or skin on contact.
 - If acid contacts eyes, flush immediately with clean water and get prompt medical attention.
 - If acid is accidentally swallowed, drink large quantities of water or milk and call a physician immediately.
 - If acid contacts skin or clothing, wash off immediately with clean water.



Inspection

1. Open the engine hood.

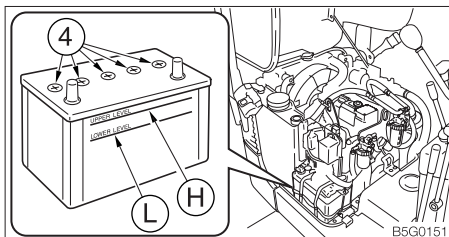

2. Inspect the battery fluid level by sight.
 - The level should be between the upper limit (H) and lower limit (L).
If it is below the lower limit (L), replenish.
3. Also check the terminals for looseness and dirt.

Replenishing

When adding distilled water, do so before starting operations in order to prevent freezing.

1. Remove the caps (4), and add distilled water until the upper limit (H).
2. Clean the cap's exhaust hole, then tighten the caps securely.

Draining the Fuel Tank

⚠ WARNING

- Do not smoke or permit open flames while handling fuel or working on the fuel system.
- Stop the engine in a well-ventilated place and allow it to cool down before performing maintenance.
- Clean up spilled fuel immediately.

Do this before operating the machine.

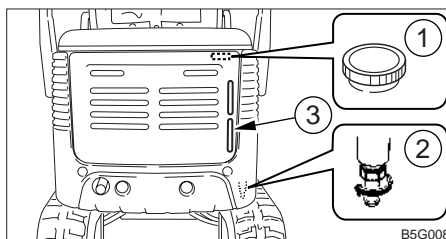

1. Open the engine hood.
2. Remove the fuel filler cap (1).
3. Place a pan under the drain plug (2).
4. Remove the drain plug (2) and drain the water and sediment from the bottom of the tank.
5. Tighten the drain plug (2).
6. While watching the sight gauge (3), add fuel.
7. Tighten the fuel filler cap (1) and closing the engine hood and lock it with the key.
8. Bleed the air.
Refer to page 129 "Bleeding the Air from the Fuel System".

Supplement: Air in the fuel system can make it difficult to start the engine and cause engine problems. Also bleed the air when the fuel tank is emptied.



Cleaning the Fuel Filter

WARNING

- Do not smoke or permit open flames while handling fuel or working on the fuel system.
- Stop the engine in a well-ventilated place and allow it to cool down before performing maintenance.
- Clean up spilled fuel immediately.

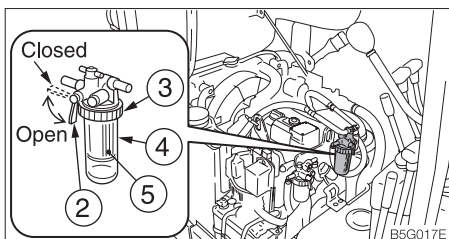

1. Open the engine hood.
2. Close the cock (2).
3. Loosen the ring (3), then remove the case (4) and element (5) and clean them.
4. Inspect the O-ring, and if there are any scratches or other irregularities, replace it.
5. Assemble the case (4) and element (5) and tighten the ring (3).
6. Open the cock (2) and bleed the air.
Refer to page 129 "Bleeding the Air from the Fuel System".

Cleaning the Water Separator

WARNING

- Do not smoke or permit open flames while handling fuel or working on the fuel system.
- Stop the engine in a well-ventilated place and allow it to cool down before performing maintenance.
- Clean up spilled fuel immediately.

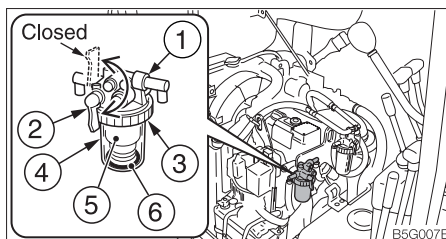

1. Open the engine hood.
2. Close the cock (2).
3. Loosen the ring (3), then remove the case (4), element (5) and indicator ring (6) and clean them.
4. Inspect the O-ring, and if there are any scratches or other irregularities, replace it.
5. Assemble the indicator ring (6), case (4) and element (5) and tighten the ring (3).
6. Open the cock (2) and bleed the air.
Refer to page 129 "Bleeding the Air from the Fuel System".



Replacing the Travel Motor Gear Oil

WARNING

- **Stop the engine and allow the machine to cool down before performing maintenance.**
- **The travel motors are hot directly after the engine is stopped. Touching them will cause burns.**
- **The gear oil is also hot and under high pressure.**
Be careful when loosening plugs. Working on the machine under these conditions could result in burns or injuries.
- **The pressure in the travel motor reduction gears case may cause oil or the plug to fly out. Loosen the plug slowly to release the pressure.**

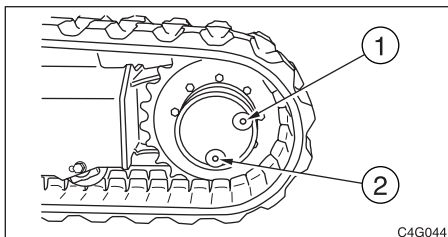

1. Set the travel motor so that plug (2) is at the very bottom.
2. Place a pan for catching the spent oil under plug (2).
3. Remove plugs (1) and (2) and drain the oil.
4. Wrap new sealing tape around the plugs.
5. Tighten plug (2).
6. Add oil through the hole for plug (1) until oil flows out of the hole.
7. Tighten plug (1).



Cleaning the Air Cleaner

⚠ WARNING

- Stop the engine and allow the machine to cool down before performing maintenance.
 - The engine, muffler, radiator and many other parts of the machine are hot directly after the engine is stopped. Touching these parts will cause burns.
- Wear required appropriate equipment such as safety glasses and filter mask when using compressed air, as metal fragments or other objects can fly and cause serious personal injury.

IMPORTANT: Be careful not to scratch the element. Do not use an element if it is damaged.

IMPORTANT: When operating the machine in very dusty places, inspection and maintenance should be performed every day.

Supplement: Do not remove and clean the inner element (option). Replace the inner element every 1000 hrs. or after every 3 cleaning of the outer element. (whichever comes first)

1. Open the engine hood.
2. Remove the hook of the rubber band (5) and free the body (4).

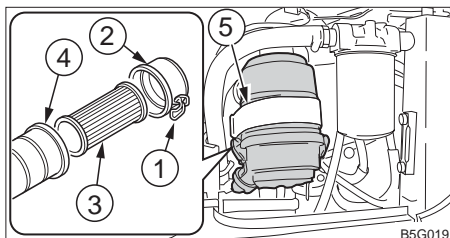

3. Loosen the clamp (1) and remove the dust cup (2).
4. Clean the inside of the dust cup (2).
5. Remove the element (3).
6. Cover the intake hole at the back of the body (4) with cloth or tape to prevent dirt from getting in.
7. Clean the inside of the body (4).



E4G033

8. Clean the element (3) with dried compressed air {294 to 490 kPa (43 to 71 psi)}.

First blow the air from the inside of the element along the flutes, then blow the air from the outside, and finally from the inside again.

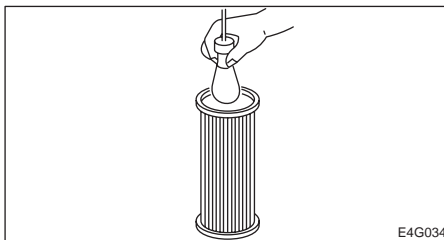

E4G034

9. Light up the inside of the element with a bulb, inspect it, and replace it if there are small holes or thin spots.
10. Remove the cloth or tape applied in step 6.
11. Install the element (3).
12. Install the dust cup (2), then fasten it with the clamp (1).
13. Fasten the body (4) with the rubber band (5).



Cleaning the Radiator Fins

WARNING

Wear required appropriate equipment such as safety glasses and filter mask when using compressed air, as metal fragments or other objects can fly and cause serious personal injury.

IMPORTANT: Be careful not to damage the radiator fins when cleaning them.

- When using compressed air or pressurized water, make sure the pressure is no higher than 200kPa (28 psi) and hold the nozzle sufficiently away from the fins.

IMPORTANT: When using water, cover the electrical system to prevent water from getting in.

IMPORTANT: When operating the machine in very dusty places, inspection and maintenance should be performed every day.

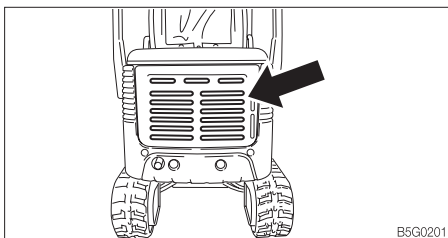

1. Blow compressed air on the radiator fins to remove mud and dirt stuck on them.

Replacing the Engine Oil and Oil Filter

Refer to page 103 “Replacing the Engine Oil and Oil Filter”.

Inspecting and Adjusting the Fan Belt

Refer to page 104 “Inspecting and Adjusting the Fan Belt”.



Replacing the Fuel Filter

WARNING

- Do not smoke or permit open flames while handling fuel or working on the fuel system.
- Stop the engine in a well-ventilated place and allow it to cool down before performing maintenance.
- Clean up spilled fuel immediately.

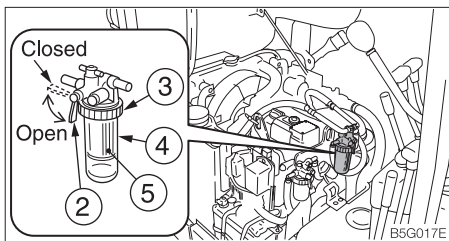

1. Open the engine hood.
2. Close the cock (2).
3. Loosen the ring (3), then remove the case (4) and element (5).
4. Clean the case (4).
5. Assemble the new element in the case (4), then tighten the ring (3).
6. Open the cock (2) and bleed the air.
Refer to page 129 “Bleeding the air from the fuel system”.

Replacing the Hydraulic Oil Return Filter

Refer to page 102 “Replacing the Hydraulic Oil Return Filter”.



Cleaning the Engine Cooling System

⚠ WARNING

- Stop the engine and allow the machine to cool down before performing maintenance.
- The engine, muffler, radiator and many other parts of the machine are hot directly after the engine is stopped. Touching these parts will cause burns.
- The engine coolant is also hot and under high pressure. Be careful when loosening caps and plugs. Working on the machine under these conditions could result in burns or injuries due to the hot coolant spurting out.
- If maintenance must be performed with the engine running, always work as a two-person team with one person ready to shut off the engine immediately while the other works on the machine.
- When performing maintenance, be sure to keep your body and clothing away from moving parts.
- Standing at the back of the machine while the engine is running is extremely dangerous, as the machine could move suddenly. Never stand at the back of the machine while the engine is running.
- Do not remove the radiator cap or drain plugs when the coolant is hot. Stop the engine, let the engine and radiator cool and loosen the radiator cap or drain plugs slowly.

1. Open the engine hood.

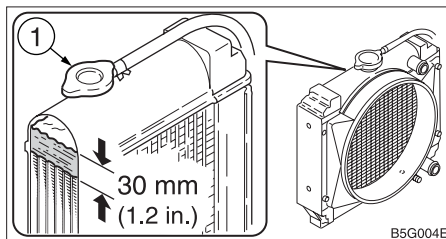

2. Place a cloth over the radiator cap (1) and loosen it gradually to release the internal pressure before removing it.

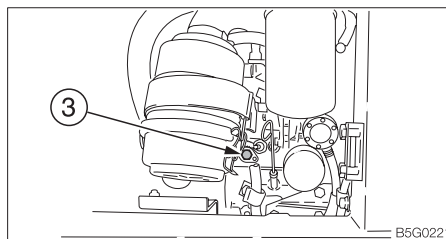
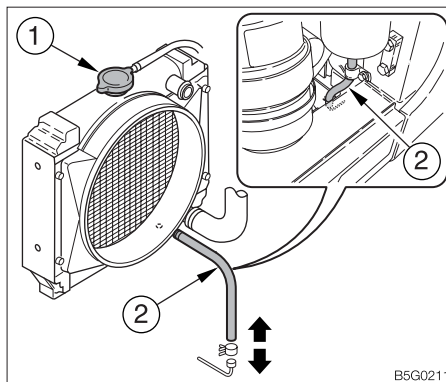

3. Place a pan for catching the spent coolant under the drain hose (2), plug (3), then loosen the drain hose (2), plug (3) and drain the coolant.



4. Tighten the drain hose (2), plug (3), then add a little cleaning agent and tap water to the radiator until it is full. Take your time doing this.

Follow the manufacturer's instructions when using the cleaning agent.

5. Run the engine at a low idle for about 30 minutes. For the first 5 minutes after starting it, pay attention to the level of the cleaning fluid, and add tap water if the level drops.
6. Stop the engine and drain the cleaning fluid.
7. Tighten the drain hose (2), plug (3), add tap water, run the engine at a low idle for about 10 minutes, then stop the engine and drain the water.
Clean repeatedly until the drained water is clear.
8. After cleaning is completed, tighten the drain hose (2), plug (3) and add new coolant up to the specified level.
9. Run the engine at a low idle, bleed the air, then stop the engine once the coolant level stabilizes at the specified level.
10. Check the coolant level, then tighten the radiator cap (1).

Replacing the Air Cleaner Element

WARNING

Stop the engine and allow the machine to cool down before performing maintenance.

- **The engine, muffler, radiator and many other parts of the machine are hot directly after the engine is stopped. Touching these parts will cause burns.**

IMPORTANT: Do not use an element if its flutes, gaskets or seals are damaged.

Supplement: Do not remove and clean the inner element (option). Replace the inner element every 1000 hrs. or after every 3 cleaning of the outer element.

(whichever comes first)

1. Open the engine hood.

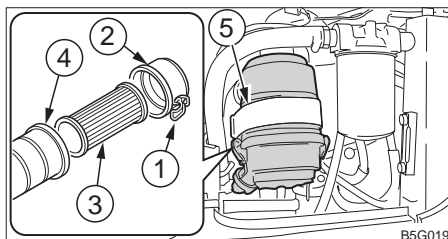

2. Remove the hook of the rubber band (5).
3. Loosen the clamp (1) and remove the dust cup (2).
4. Clean the inside of the dust cup (2).
5. Remove the element (3).
6. Cover the intake hole at the back of the body (4) with cloth or tape to prevent dirt from getting in.
7. Clean the inside of the body (4).
8. Remove the cloth or tape applied in step 6.
9. Install the new element.
10. Install the dust cup (2), then fasten it with the clamp (1).
11. Fasten the body (4) with the rubber band (5).



Replacing the Travel Motor Gear Oil

Refer to page 110 “Replacing the Travel Motor Gear Oil”.

Inspecting and Adjusting the Engine Valve Clearance

This operation requires experience. Have it performed by a Takeuchi sales or service outlet.

Retightening the Engine Cylinder Head Bolts

This operation requires experience. Have it performed by a Takeuchi sales or service outlet.

Inspecting the Engine Fuel Injection Pressure and Spray Condition

This operation requires experience. Have it performed by a Takeuchi sales or service outlet.



Replacing the Hydraulic Oil and Cleaning the Suction Strainer

⚠ WARNING

- Stop the engine and allow the machine to cool down before performing maintenance.
- The engine, hydraulic lines and many other parts of the machine are hot directly after the engine is stopped. Touching these parts will cause burns.
- The hydraulic fluid is also hot and under high pressure. Be careful when loosening caps and plugs. Working on the machine under these conditions could result in burns or injuries due to the hot oil spurting out.
- Oil may spurt out if caps or filters are removed or pipes disconnected before releasing the pressure in the hydraulic system.
- Gradually loosen the vent plug to relieve tank pressure.
- When removing plugs or screws or disconnecting hoses, stand to the side and loosen slowly to gradually release the internal pressure before removing.

1. Slew 45° clockwise and set the machine to the hydraulic oil level inspection posture. Refer to page 100 "Inspecting the Hydraulic Oil Level and Replenishing".
2. Open the engine hood.

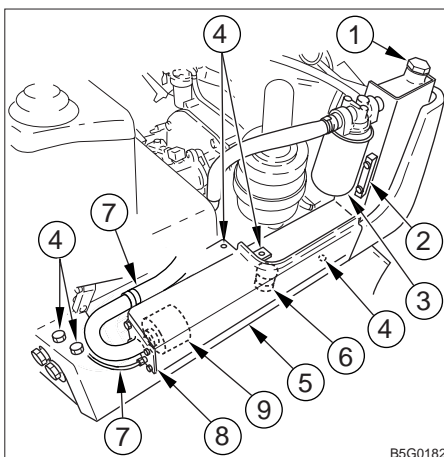

3. Loosen the bolts (4) and remove the cover (5).
4. Slowly turn the vent plug (1) to relieve tank pressure, then remove.
5. Using a filter wrench, turn the filter (3) counterclockwise and remove it.
6. Clean the surface of installation of the filter stand.
7. Apply a thin layer of oil to the packing of the new filter.
8. Install the new filter by hand.
9. Tighten 3/4 more turns with the filter wrench after the filter packing comes in contact with the surface of installation.
10. Place a pan for catching the spent oil under the drain plug (6).
11. Loosen the drain plug (6) and drain the hydraulic oil.
12. Loosen the hose clip, then remove the hoses (7).
13. Remove the bolts, then remove the flange (8).
14. Remove the suction strainer (9) and clean it.
15. Clean the inside of the hydraulic tank.
16. Install the suction strainer (9) to the flange (8).



17. Install the flange (8) and connect the hoses (7).
18. Tighten the drain plug (6).
19. Insert hydraulic oil through the hole in the vent plug (1), adding hydraulic oil to between the upper limit (H) and lower limit (L) of the sight gauge (2).
20. Follow the procedure under "Bleeding the air" to bleed the air from the hydraulic oil circuit.
21. Set the machine to the hydraulic oil level inspection posture and inspect the level once the temperature of the oil has dropped.
Refer to page 100 "Inspecting the Hydraulic Oil Level and Replenishing".
22. Pressurize the hydraulic tank.
Refer to page 100 "Pressurizing the hydraulic tank".

Bleeding the air

IMPORTANT: After replacing the hydraulic oil, bleed the air from the hydraulic oil circuit and hydraulic devices. Failure to do so may damage the hydraulic devices.

1. Start the engine and run it at low idle for 10 minutes.
2. Set the engine to a low idle, then extend and retract all the cylinders 4 or 5 times, without going to the stroke end.
3. Run the engine at high speed, then extend and retract all the cylinders 4 or 5 times, without going to the stroke end.
4. Set the engine back to a low idle, then extend and retract all the cylinders 4 or 5 times to the stroke ends.

Inspecting the Engine Fuel Injection Timing

This operation requires experience. Have it performed by a Takeuchi sales or service outlet.

Inspecting the Engine Fuel Injection Valve

This operation requires experience. Have it performed by a Takeuchi sales or service outlet.



Replacing the Bucket

WARNING

- Before performing maintenance or repairs under the machine, set all working equipment against the ground or in the lowermost position.
- If maintenance must be performed with the engine running, always work as a two-person team with one person sitting in the operator's seat while the other works on the machine.
 - When performing maintenance, be sure to keep your body and clothing away from moving parts.
- Wear required appropriate equipment such as safety glasses and filter mask when using hammers, as metal fragments or other objects can fly and cause serious personal injury.
- When lining up the pin holes, always do so by sight. Your finger may be cut off if you stick it into the hole.

Removal

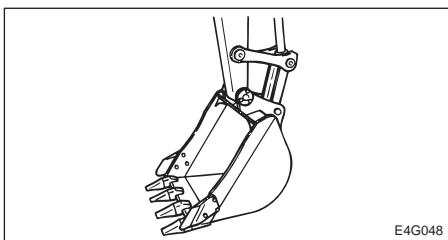

1. Ground the bucket as shown on the diagram above in a stable position.

Supplement: When removing pins, set the bucket so that it is just gently against the ground. If it is strongly against the ground, the resistance will be great and it will be difficult to remove the pin.

2. Set the safety lock lever to the locked position and stop the engine.
3. Remove the ring of the lock pin (1) and remove the lock pin.

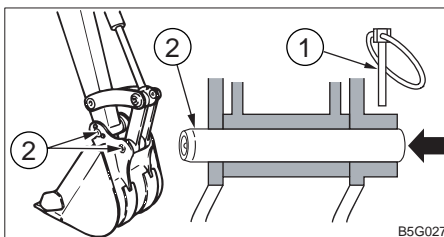

4. Hammer pin (2) out of the bucket.
5. Remove the bucket.

Installation

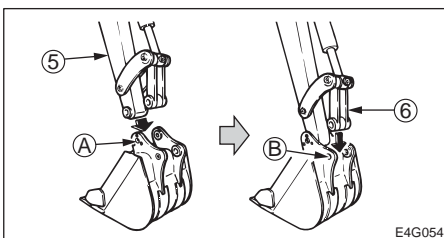

1. Line up pin hole (A) in the bucket with the pin hole in the arm (5), and install the pin (2).
2. Operate the cylinder, line up pin hole (B) in the bucket with the pin hole in the link arm (6), and install the pin (2).

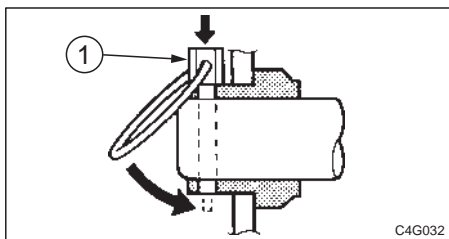

3. Line up the turn prevention holes, install lock pin (1), and set the ring on the inner side.



Inspecting the Rubber Crawlers

Repair or replace the rubber crawlers if their conditions are as described below. Consult a Takeuchi sales or service outlet about repairs or replacement.

Rubber crawler

Replace the crawler if the entire crawler is stretched and cannot be adjusted.

(1) Lug

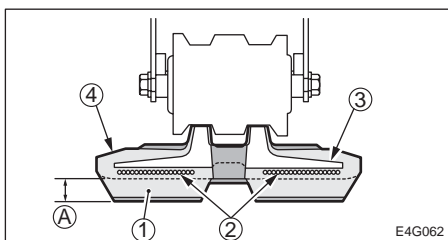

Replace if the height of (A) is 5 mm (0.2 in.) or below.

(2) Steel cord

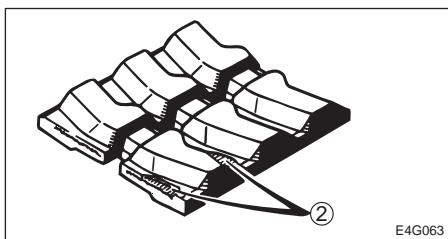

Replace if the steel cord is exposed over 2 or more links.

Replace if half or more of the steel cords on one side are cut.

(3) Metal core

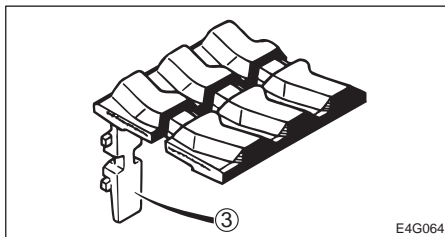

Replace if even one metal core is off.

(4) Rubber

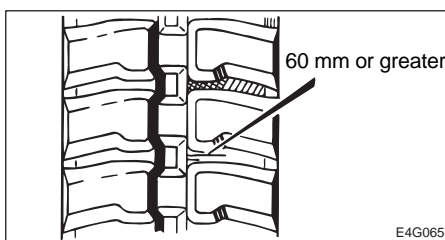

Repair if there are cracks of 60 mm (2.4 in.) or greater in length.

If the steel cord is visible, repair as soon as possible, regardless of the length of the crack.



Replacing the Rubber Crawlers

WARNING

- If you must work beneath the raised machine or equipment, always use wood blocks, jack-stands or other rigid and stable supports. Never get under the machine or working equipment if they are not sufficiently supported. This procedure is especially important when working on hydraulic cylinders.
- If maintenance must be performed with the engine running, always work as a two-person team with one person sitting in the operator's seat while the other works on the machine.
- When performing maintenance, be sure to keep your body and clothing away from moving parts.

Removal

1. Fully release the tension of the rubber crawler.

Refer to page 105 "Inspecting and Adjusting the Crawler Tension".

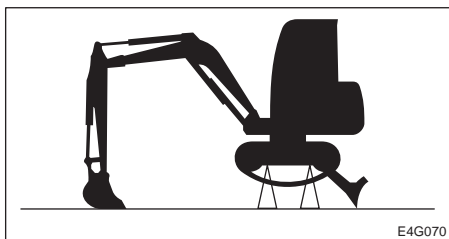

2. Use the working equipment to lift the body.

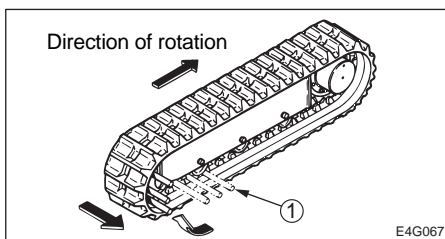

3. Set an iron pipe (1) in the rubber crawler and turn the sprocket slowly in the reverse direction.
4. Turn until the iron pipe (1) is directly next to the idler and the rubber crawler lifts away from the idler, then stop turning the sprocket.
5. Slide the rubber crawler sideways and remove it from the crawler frame. Remove the other rubber crawler using the same procedure.

Installation

1. Use the working equipment to lift the body.

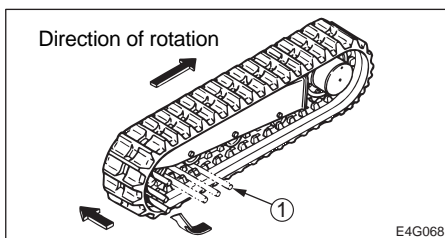

2. Set the rubber crawler on the sprocket.
3. Set an iron pipe (1) in the rubber crawler and turn the sprocket slowly in the reverse direction.
4. Turn until the iron pipe (1) is directly next to the idler and the rubber crawler lifts away from the idler, then stop turning the sprocket.
5. Slide the rubber crawler inward, engage it on the idler, then pull out the iron pipe.



6. Check that the rubber crawler is securely engaged on the sprocket and idler.
7. Tighten the rubber crawler to the standard tension.
Refer to page 105 “Inspecting and Adjusting the Crawler Tension”.
8. Install the other rubber crawler using the same procedure.

**Procedures for storage**

If the machine is to be stored for 30 days or more, store it indoors. If it must be stored outdoors, stop it on wood laid out on a flat surface and place a waterproof cover over it so that it stays dry.

1. Clean the machine.
2. Inspect for oil leakage, water leakage and loose nuts and bolts.
3. Add fuel and replace the hydraulic oil and oil.
4. To prevent rusting and freezing, replace the engine coolant with long-life coolant (LLC).

Refer to page 114 "Cleaning the Engine Cooling System".

5. Use the grease gun to supply grease to the grease nipples.
6. Fully contract the bucket and arm cylinders and ground the bucket and dozer blade.
7. Apply rust-prevention oil to the hydraulic cylinder rods.
8. Disconnect the cable from the battery's "-" terminal and cover the battery to prevent freezing.

During storage**! WARNING**

- **Do not operate the engine in an enclosed area without adequate ventilation.**
 - **If natural ventilation is poor, install ventilators, fans, exhaust extension pipes or other artificial venting devices.**
-

1. To prevent rusting, operate the machine once a month so that the oil is fully circulated.
2. Inspect the battery and recharge it if necessary.
Have the battery charged by a Takeuchi sales or service outlet.

Starting the machine after storage

IMPORTANT: If the "Procedures for storage" have not been performed and the machine has been stored for a long period of time, consult a Takeuchi sales or service outlet before reusing the machine.

1. Wipe off the rust-prevention oil that was applied to the hydraulic oil cylinders' piston rods.
2. Add fuel, oil and grease to all parts.



TROUBLESHOOTING

Symptoms that are not Malfunctions	126
If the Engine Overheats	127
If the Battery Goes Dead	128
After the Fuel Runs Out	129
If a Fuse Blows	130
If a Warning Lamp is illuminated	131
Other Symptoms	132
Towing	134



The following symptoms are not malfunctions:

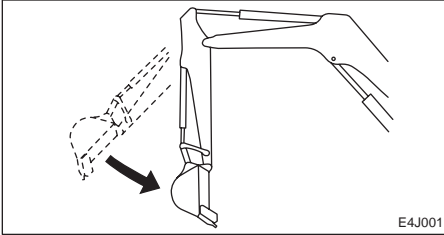

- When the arm reaches the vertical position while contracting it while the engine is running at low speed, the contracting speed slows down momentarily.

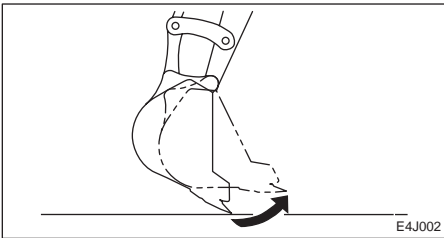

- When the bucket teeth reach the horizontal position while the engine is running at low speed, the speed of bucket movement slows down momentarily.
- The slew motor produces noise at the beginning and end of the slewing operation.
- The travel motor produces noise when stopped suddenly during high speed travel.
- The control valve produces noise if excessive force is applied to the working equipment and when the stroke end is reached.
- Performance decreases when an attachment weighing more than a standard arm or bucket is mounted.



WARNING

- Do not open the engine hood when there is steam coming from the engine room. The steam or hot water may spurt out, resulting in burns.
- Do not remove the radiator cap or drain plugs when the coolant is hot. Stop the engine, let the engine and radiator cool and loosen the radiator cap or drain plugs slowly.
- Stop the engine and allow the machine to cool down before performing inspection and maintenance.

The following symptoms indicate overheating:

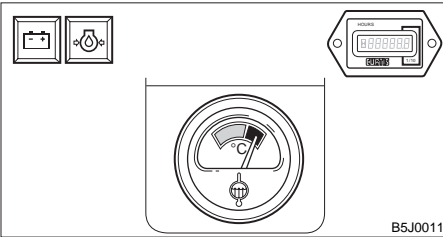

- The water temperature gauge is in the red zone.
- The engine slows down and the force decreases.
- Steam comes from the engine room.

Procedure

1. Park the machine in a safe place.
 2. With the engine hood closed, inspect whether steam is coming from the engine room.
 3. If there is steam, stop the engine immediately and contact a Takeuchi sales or service outlet for repairs.
If there is no steam, run the engine at low idle and let the water temperature decrease.
 4. Once the water temperature gauge drops to the green zone, stop the engine.
 5. Once the engine is cool, perform the following inspections and procedures:
 - Fan belt slack Adjust.
Refer to page 104.
 - Coolant level Add.
Refer to page 97.
 - Water leakage Repair.
 - Radiator fins Clean.
Refer to page 112.
 - Sediment in cooling system Clean.
Refer to page 114.
- If the problem persists after the above procedures are taken, contact a Takeuchi sales or service outlet for repairs.



If the Battery Goes Dead

The following symptoms indicate that the battery is dead:

- The starter motor does not turn or turns weakly, and the engine does not start.
- The horn is weak.

Procedure

Use jumper cables and start the engine using the rescue vehicle's battery.

WARNING

- Use jumper cables only in the recommended manner. Improper use of jumper cables can result in battery explosion or unexpected machine motion.
 - Do not let the problem vehicle and rescue vehicle touch each other.
 - Do not let the “+” and “-” clips of the jumper cables touch each other.
 - Connect the jumper cables to the “+” terminals first, and disconnect them from the “-” terminals (ground) first.
 - Connect the final clip of the jumper cable to a point as far away from the battery as possible.
- Use safety glasses when using jumper cables to start the machine.

IMPORTANT: Use jumper cables and clips of a size suited to the battery's capacity. Do not use damaged or corroded jumper cables and clips.

IMPORTANT: The rescue vehicle's battery must have the same capacity as the problem vehicle's battery.

IMPORTANT: Connect the clips securely.

Connecting the jumper cables

IMPORTANT: Set the starter keys of both the rescue vehicle and problem vehicle to the OFF position.

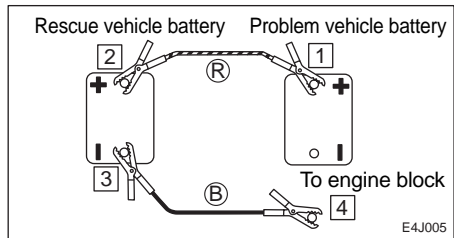

1. Connect the clip of jumper cable (R) to the problem vehicle's “+” terminal.
2. Connect the other clip of jumper cable (R) to the rescue vehicle's “+” terminal.
3. Connect the clip of jumper cable (B) to the rescue vehicle's “-” terminal.
4. Connect the other clip of jumper cable (B) to the problem vehicle's engine block. Connect the clip as far from the battery as possible.

Starting the engine

1. Check that the clips are securely connected to the terminals.
2. Start the rescue vehicle's engine and run it at high speed.
3. Start the problem vehicle's engine.

**Disconnecting the jumper cables**

Once the engine starts, disconnect the jumper cables following the connection procedure in reverse order.

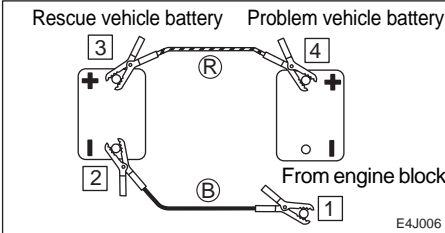

1. Disconnect the clip of jumper cable (B) from the problem vehicle's engine block.
2. Disconnect the other clip of jumper cable (B) from the rescue vehicle's "-" terminal.
3. Disconnect the clip of jumper cable (R) from the rescue vehicle's "+" terminal.
4. Disconnect the other clip of jumper cable (R) from the problem vehicle's "+" terminal.

Recharging

Have a Takeuchi sales or service outlet recharge batteries that have gone dead.

Bleeding the Air from the Fuel System

1. Add fuel.
2. Open the water separator and fuel filter cocks.

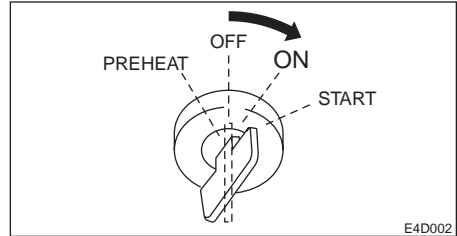

3. Turn the starter key to the ON position and hold it there for about 20 seconds. The automatic air bleeder bleeds the air from the fuel system.
4. Start the engine and inspect for fuel leakage.

Supplement: Air in the fuel system can make it difficult to start the engine and cause engine problems. Also bleed the air when the fuel tank is emptied.



If a light does not turn on or the electric system does not operate, a fuse may be blown. Inspect the fuses.

Inspecting and Replacing the Fuse

WARNING

If the fuse blows as soon as it is replaced, there is a problem with the electric system. Continued use may lead to fire. Consult a Takeuchi sales or service outlet.

1. Turn the starter key to the OFF position to stop the engine.

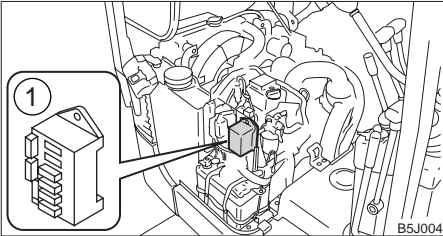

2. Open the fuse box (1) and inspect for any blown fuses.

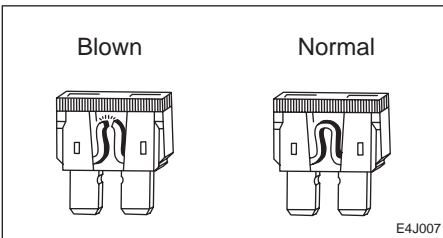

3. If a fuse is blown, replace it with a fuse of the same capacity.

Fuse Layout and Circuits Protected

Capacity	Protected circuit
10A	Horn
10A	Water temperature gauge
10A	Boom light
30A	Stop solenoid

Inspecting the Fusible Link

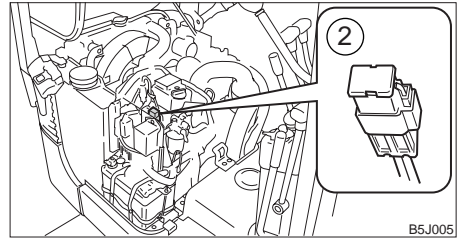



If the electric power is not switched on after turning the starter switch to the ON position, the cartridge type fusible link (2) might be blown open. Open the engine hood and inspect. If the fusible link is blown, please contact a Takeuchi sales or service.

Supplement: A fusible link is a large piece of fuse wiring which is mounted in a circuit which carries a large electrical current. Link a regular fuse, the fusible link protects the electrical parts and wiring from damage due to abnormally large currents.

**If a Warning Lamp is illuminated**

If a warning lamp is illuminated during operation, park the machine in a safe place and perform the procedures described below.

Warning lamp	Lamp name	Procedure
 OSOB080	Battery charge warning lamp	There is a problem with the fan belt or alternator. Inspect the fan belt for slack or breakage and adjust as necessary. If the lamp continues illuminating after maintenance, there is a problem with the alternator. Consult a Takeuchi sales or service outlet. Refer to page 104 "Inspecting and Adjusting the Fan Belt".
 OSOB070	Engine oil pressure warning lamp	Inspect the engine oil level. If the lamp is illuminating even though the level is normal or if it continues illuminating after oil is added, consult a Takeuchi sales or service outlet. Refer to page 98 "Inspecting and Replenishing the Engine Oil".



For symptoms not included on the table below or if the problem persists after the proper procedures have been taken, consult a Takeuchi sales or service outlet.

Symptom	Main cause	Procedure
Hoe attachment, slewing or traveling operation not possible	<ul style="list-style-type: none">● Safety lock lever is raised	<ul style="list-style-type: none">● Lower the safety lock lever. Refer to page 43.
Digging force is insufficient	<ul style="list-style-type: none">● Insufficient hydraulic oil level● Hydraulic oil is not heated● Air cleaner is clogged● Hydraulic oil is not of suitable type	<ul style="list-style-type: none">● Replenish to the prescribed level. Refer to page 100.● Perform the warm-up procedure. Refer to page 58.● Clean the air cleaner. Refer to page 111.● Replace the hydraulic oil. Refer to page 117.
Traveling is not possible or not smooth	<ul style="list-style-type: none">● Stones or foreign objects are stuck	<ul style="list-style-type: none">● Remove the foreign object.
Machine does not travel straight forward	<ul style="list-style-type: none">● Stones or foreign objects are stuck● Faulty crawler tension adjustment	<ul style="list-style-type: none">● Remove the foreign object.● Adjust the crawler to the prescribed tension. Refer to page 105.
Slewing is not possible or not smooth	<ul style="list-style-type: none">● Insufficient grease on slew bearing	<ul style="list-style-type: none">● Add grease. Refer to page 106.



Symptom	Main cause	Procedure
Hydraulic oil temperature is too high	<ul style="list-style-type: none">● Insufficient hydraulic oil	<ul style="list-style-type: none">● Replenish to the prescribed level. Refer to page 100.
Starter motor turns but engine does not start	<ul style="list-style-type: none">● Insufficient fuel● Air in fuel system● Water in fuel system	<ul style="list-style-type: none">● Add fuel. Refer to page 99.● Bleed the air. Refer to page 129.● Drain the water. Refer to page 108.
Crawlers slip off	<ul style="list-style-type: none">● Crawlers are too loose	<ul style="list-style-type: none">● Adjust the tension. Refer to page 105.
Engine exhaust is white or bluish	<ul style="list-style-type: none">● Excessive engine oil● Insufficient fuel	<ul style="list-style-type: none">● Adjust to the prescribed level. Refer to page 98.● Replace the fuel.
Engine exhaust is occasionally black	<ul style="list-style-type: none">● Air cleaner is clogged	<ul style="list-style-type: none">● Clean the air cleaner. Refer to page 111.
Irregular noise is produced from the engine (combustion or mechanical noise)	<ul style="list-style-type: none">● Low quality fuel is being used● Engine is overheating● Damage in muffler	<ul style="list-style-type: none">● Replace the fuel.● If the Engine Overheats Refer to page 127.● Replace the muffler. (Request at a sales or service outlet.)

**⚠ WARNING**

When towing, selecting the wrong wire rope, inspecting improperly, or towing in the wrong way could lead to accidents resulting in serious injury or death.

- The wire rope breaking or coming detached could be extremely dangerous. Use a wire rope suited for the required towing force.
- Do not use a wire rope that is kinked, twisted or otherwise damaged.
- Do not apply strong loads abruptly to the wire rope.
- Use safety gloves when handling the wire rope.
- Make sure there is an operator on the machine being towed as well as on the machine that is towing.
- Never tow on slopes.
- Do not let anyone near the wire rope while towing.

Towing the Machine

Use the procedure described below to tow heavy objects or the machine itself if it should get stuck in the mud and not be able to get out on its own.

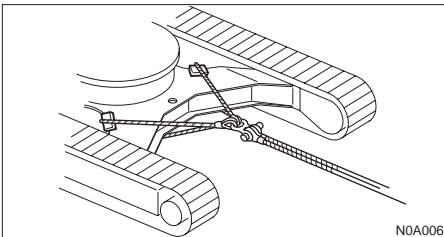

1. Fasten the wire rope to the frame.
2. Place splints or other objects between the wire rope and frame to prevent the machine and wire rope from getting damaged.
3. Move the machine to tauten the wire rope.
4. Move the machine slowly and tow.



SPECIFICATIONS

Main Specifications	137
Machine Dimensions	138
Operating Range	140
Lifting Capacities	143

MEMO



Main Specifications

TYPE		With CANOPY	CANOPY Less
MASS			
Machine mass kg (lb.) (not including operator)	With rubber crawlers	855 (1880)	810 (1790)
PERFORMANCE			
Bucket capacity m ³ (cu.ft.) (standard bucket)	Heaped		0.018 (0.64)
	Struck		0.013 (0.46)
Slew speed min ⁻¹ (rpm)		9.3 (9.3)	
Travel speed km/h (mph)	Rubber crawler	1st	2.0 (1.24)
		2nd	3.9 (2.42)
Gradeability (degrees)		25	
Ground pressure kPa (psi)	With rubber crawlers	25.1 (3.64)	23.8 (3.46)
Noise level dB(A)	Sound-power level		L _{WA} 91
	Sound-pressure level		L _{pA} 80
ENGINE			
Manufacturer and model		Yanmar 2TNV70-PTB diesel engine	
Rated output	kW / min ⁻¹ (hp / rpm)	7.1 / 2400 (9.6 / 2400)	
Displacement	ml (cu.in.)	569 (34.7)	
Starter	V - kW	12 - 1.0	
Alternator	V - kW	12 - 0.18	
Battery	V - Ah	12 - 34	



SPECIFICATIONS
Machine Dimensions

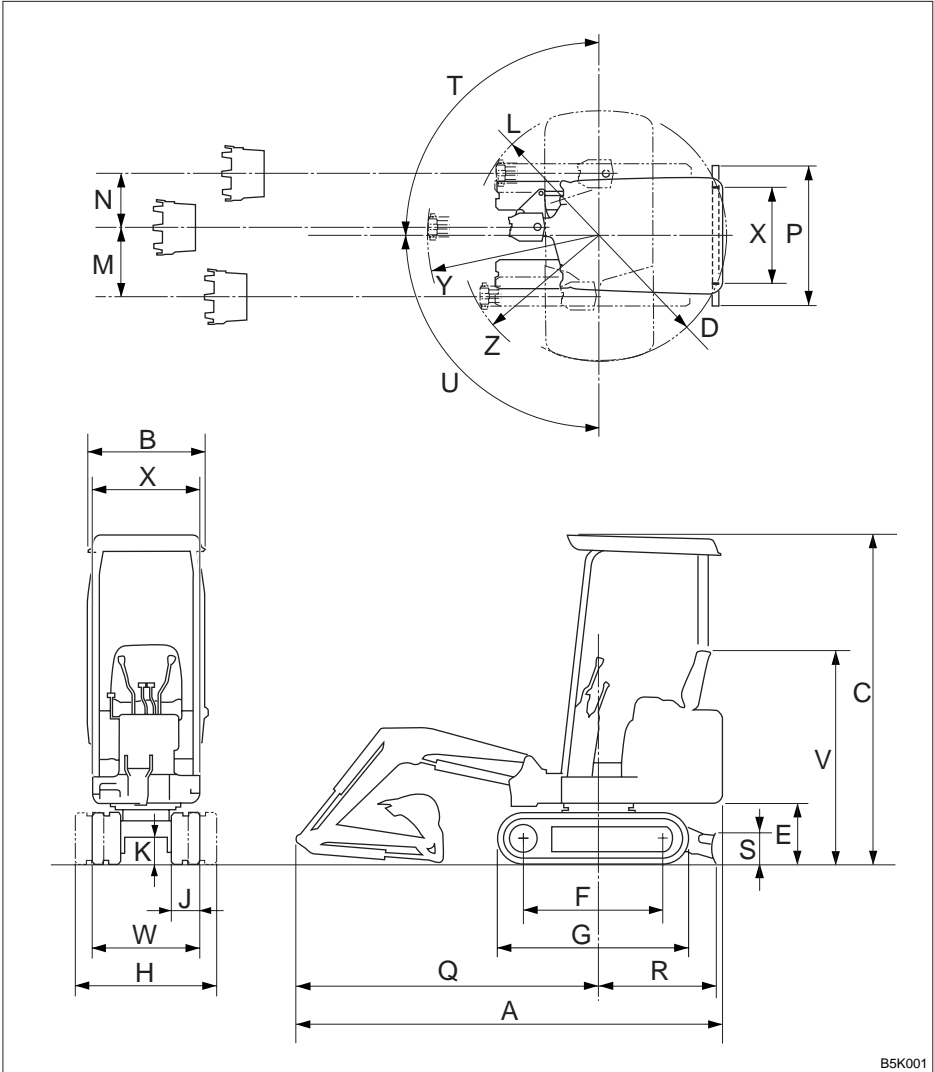

B5K001

**Machine Dimensions**

Units: mm (inches)

	Standard Arm	Long Arm
A	2710 (106.7)	2740 (107.9)
B	740 (29.1)	←
C	2110 (83.1) / 2195 (86.5)*	←
D	800 (31.5)	←
E	385 (15.2)	←
F	900 (35.4)	←
G	1220 (48.1)	←
H	900 (35.4)	←
J	180 (7.1)	←
K	160 (6.3)	←
L	790 (31)	825 (32.5)
M	440 (17.3)	←
N	340 (13.4)	←
P	900 (35.4)	←
Q	1920 (75.6)	1955 (77)
R	740 (29)	←
S	200 (7.9)	←
T	90°	←
U	90°	←
V	1375 (54.1)	←
W	680 (26.8)	←
X	680 (26.8)	←
Y	1080 (42.6)	1125 (44.3)
Z	880 (34.6)	915 (36.1)

* Option: With Lift Eyes

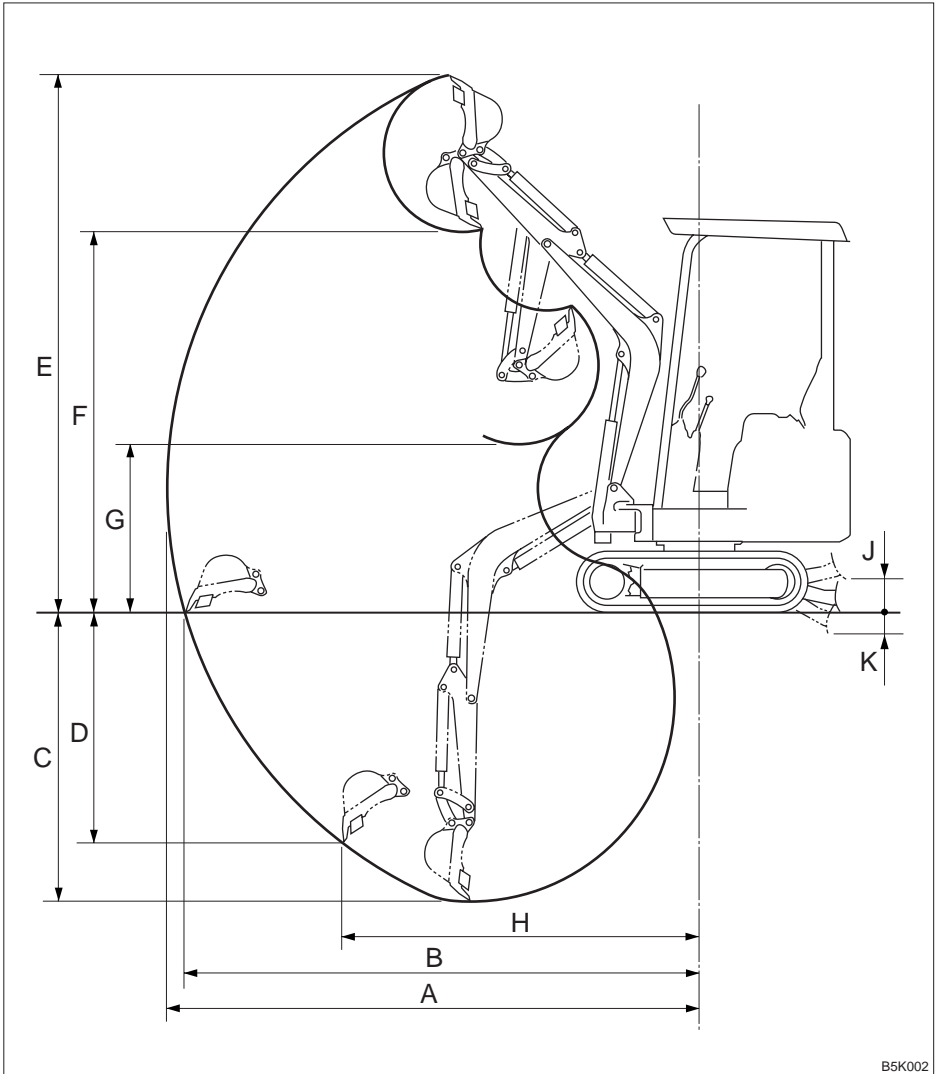

B5K002

**Operating Range**

Units: mm (inches)

	Item	Standard Arm	Long Arm
A	Max. digging radius	2825 (111.3)	2970 (116.9)
B	Max. ground digging radius	2730 (107.6)	2880 (113.4)
C	Max. digging depth	1530 (60.3)	1680 (66.1)
D	Max. vertical digging depth	1220 (48)	1370 (53.9)
E	Max. digging height	2860 (112.5)	2975 (117.1)
F	Max. dumping height	2030 (79.9)	2145 (84.4)
G	Min. dumping height	900 (35.4)	760 (29.9)
H	Max. vertical digging radius	1890 (74.3)	1915 (75.4)
J	Max. raising height	155 (6.1)	←
K	Max. lowering depth	120 (4.7)	←

MEMO

**Rated lift capacity chart**

- The loads in the charts do not exceed 87% of hydraulic lift capacity or 75% of tipping load.
- Rated lift capacities limited by rated hydraulic lift capacity are identified by an asterisk(*)
- The mass of slings and any auxiliary lifting devices shall be deducted from the rated load to determine the net load that may be lifted.
- The load point is the bucket hinge pin, and the bucket posture is with the standard bucket completely retracted under the arm.
- Units: daN (lbs.)

Load hooking system

A load hooking system with all of the following capacities must be provided and used.

1. A system which can withstand a weight of two times the rated lift capacity no matter at what position the load is applied.
2. A system in which there is no risk of the lifted load falling from the hooking device, for example one equipped with a hook slippage prevention device.
3. A system in which there is no risk of the hooking system slipping from the hoe attachment.

 **WARNING**

- **DO NOT attempt to lift or hold any load that is greater than these rated values at their specified load radii and height.**
 - **All rated lift capacities are based on the machine being level and on a firm supporting surface. For safe working loads, the user is expected to make due allowance for the particular job conditions such as soft or uneven ground, non-level condition, side loads, hazardous conditions, experience of personnel, etc. The operator and other personnel should fully acquaint themselves with the operator's manual furnished by the manufacturer before operating this machine, and rules for safe operation of equipment shall be adhered to at all times.**
-



Equipped with Standard Arm

Over Front; Dozer Blade Up

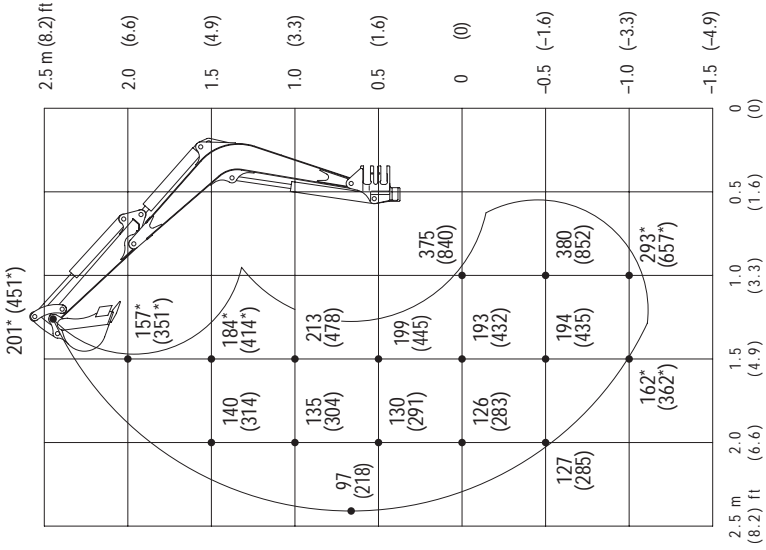

units : daN (lbs.)



Equipped with Standard Arm

Over Side Upper: Crawler width 900mm
Lower: Crawler width 680mm

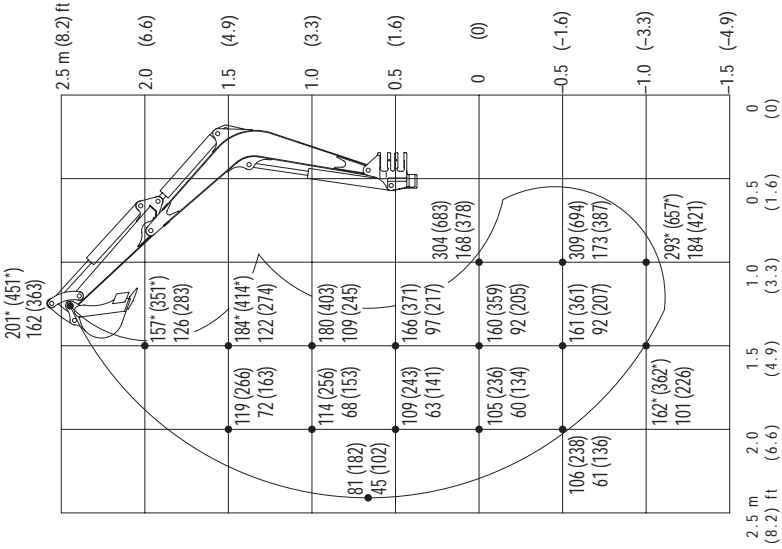

Over Rear

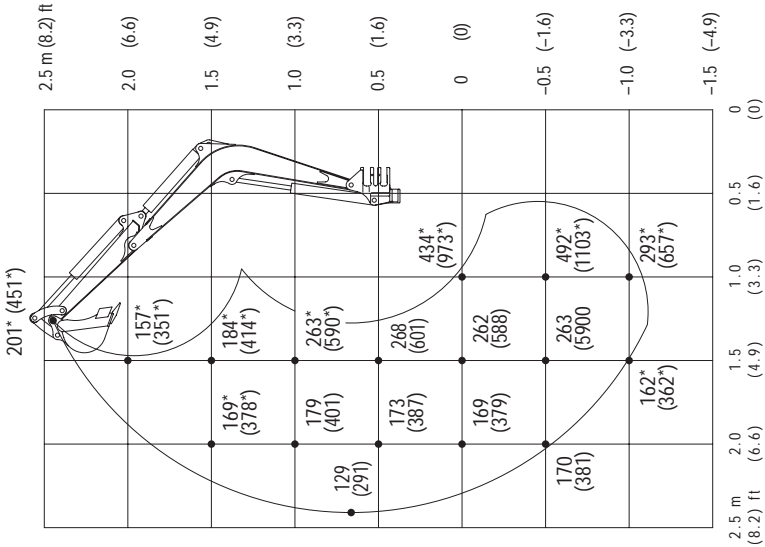

units : daN (lbs.)



Equipped with Long Arm

Over Front; Dozer Blade Up

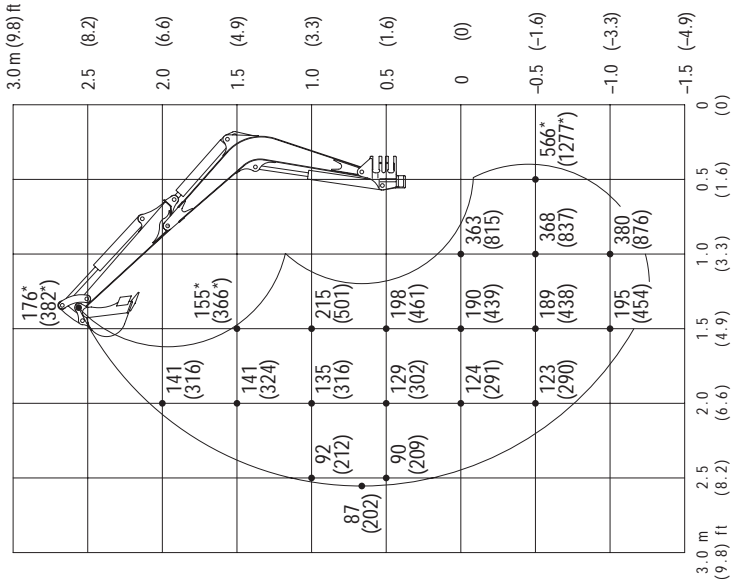

units : daN (lbs.)



Equipped with Long Arm

Over Side Upper: Crawler width 900mm
Lower: Crawler width 680mm

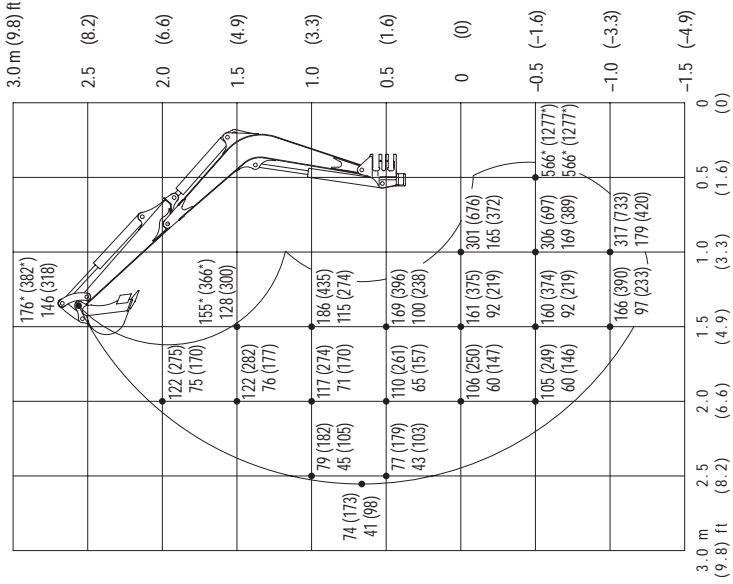

Over Rear

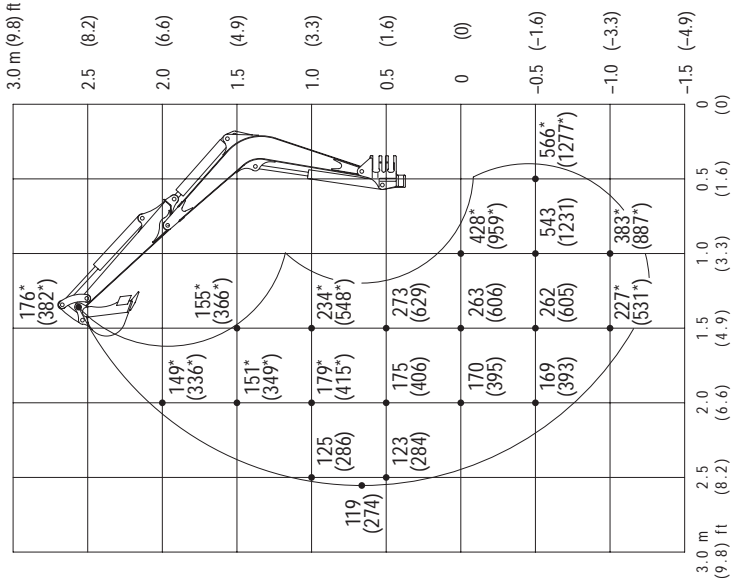

units : daN (lbs.)



OPTIONS

General Precautions	150
Canopy (When equipped with Lift eyes)	152
Hydraulic Breaker	153
3-Hole Bucket	155
Travel Alarm	158
Biodegradable Oil	159
Seat Belt	160



Precautions on Safety

WARNING

Heed the following when removing or installing an attachment or option:

- Consult with a Takeuchi dealer before installing optional attachments.
 - Do not use attachments that have not been approved by Takeuchi or a Takeuchi dealer. Doing so may compromise safety or adversely affect the machine's operation or service life.
 - Takeuchi will not be held responsible for any injuries, accidents or damage to products caused by the use of a non-approved attachment.
 - Choose a flat, hard surface to perform the operations. Also make sure there is enough light and good ventilation.
 - Clean the area, remove any articles that may get in the way or be dangerous, and remove any spilled oil or grease.
 - When performing lifting operations, determine a person to lead the operations and always follow that person's instructions.
 - Follow the leader's instructions on operating methods and procedures.
 - Determine a signal leader and heed this person's signals.
 - When removing or installing the hoe attachment, place it in a stable position so that it does not tip over.
 - Due to the risk of loads falling and/or hitting people, do not allow unauthorized personnel in the work area.
 - Use the crane to carry heavy objects (25 kg (55 lb.) or greater).
 - When removing heavy parts, be sure to prop them up before removing them. When lifting them with a crane, be careful to balance them properly.
 - Operating with loads suspended with the crane is dangerous. Place loads on a stand and check for safety.
 - When attaching the boom or arm, failure to follow proper procedures could result in serious damage. Consult with a Takeuchi dealer beforehand.
-

Precautions on Installing Attachments

After replacing optional attachments or other special attachments, test-run them, then inspect the hydraulic oil level and add oil if necessary.

In addition, consult with a Takeuchi dealer for details of removal and installation procedures.



Precautions on Operating Attachments

WARNING

Long attachments reduce machine stability. When traveling down steep slopes or slewing on slopes, the machine may lose its balance and tip over.

The following operations are particularly dangerous. Do not perform them.

- Traveling down slopes with the attachment lifted
- Traveling across slopes
- Slewing on slopes

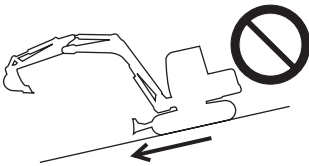

OE3A2531

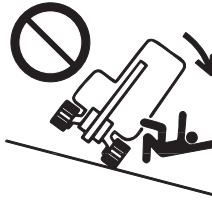

OE3A271

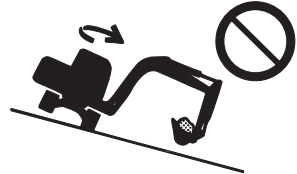

OE3A331

- When heavy attachments are installed, the overslew (the distance from where the operation to stop slewing is performed until slewing stops completely) increases and mistakes in judgment may result in the attachment hitting surrounding objects. Allow for plenty of room between the attachment and obstacles. In addition, the natural drop (the gradual dropping of the attachment under its own weight when it is stopped in midair) also increases when heavy attachments are installed.
- The machine can tip over more easily in the lateral direction than in the longitudinal direction.
 - Do not slew (swing) sideways with excessive weight at the front. In particular do not slew sideways on slopes.
 - The front is heavier for machines equipped with breakers, crushers or telescopic arms than for machines equipped with the standard bucket. Do not operate such machines sideways, especially with the digging arm (boom) downhill.
- When a long arm or a telescopic arm is installed, the operating range suddenly increases and mistakes in judgment may result in the attachment hitting surrounding objects. Allow for plenty of room between the attachment and obstacles.



Lifting the Machine

⚠ WARNING

- Know and use correct crane signals.
- Inspect the lifting equipment daily for damaged or missing parts.
- Keep all other persons out of the area when lifting. Do not move the machine over the heads of their persons.
- Do not lift the machine with an operator(s) on it.
- When lifting, use a wire rope with sufficient strength with respect to the machine's weight.
- Do not lift with the machine in a posture other than the one described in the procedure below. Doing so is dangerous as it may result in the machine losing its balance.

IMPORTANT: This lifting method applies to machines with standard specifications.

Lifting posture

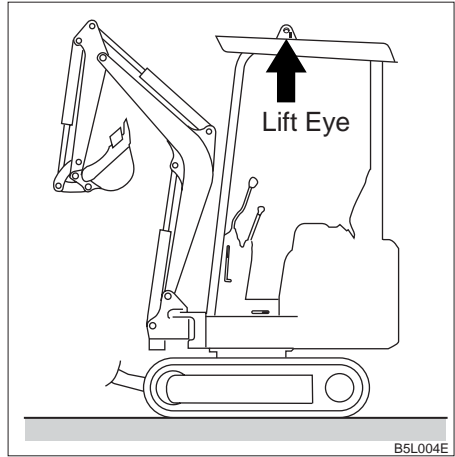

1. Park the machine on a level surface.
2. Set the slew lock lever to the locked position.
3. Fully extend the bucket, arm and boom cylinders.
4. Raise the dozer blade.
5. Set the safety lock lever securely to the locked position.
6. Stop the engine and remove the starter key.
7. Fix the sling to the lift eyes.

Lifting

1. Lift slowly until the machine just leaves the ground.
2. Stop lifting until the machine is stable.
3. Lift slowly.

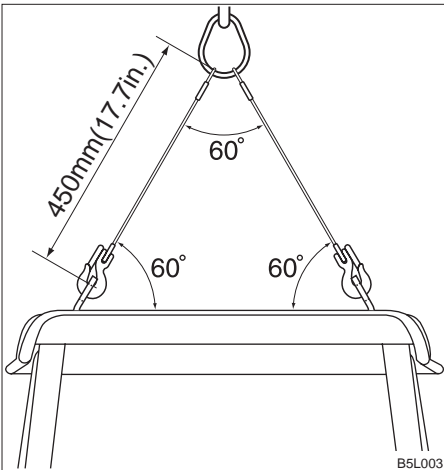

When lifting this machine with a crane, use a two leg sling with a 60 degree sling angle. Each leg of the sling must have a minimum length of 450mm(17.7 in.).



For handling of the breaker, read the hydraulic breaker's manual, provided separately.

WARNING

Do not use a breaker with the crawler width narrowed!

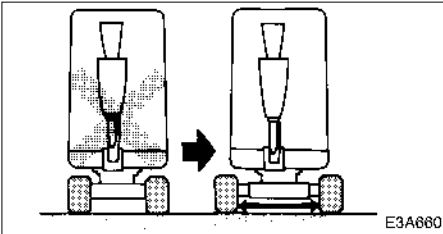

- Always operate the machine with the crawler width at the maximum to increase machine stability. The smaller the crawler width, the greater the possibility the machine can tip over.

IMPORTANT: When mounting devices, select devices suited for this machine. For advice on selecting device, contact a Takeuchi sales or service outlet.

Precautions on Operating

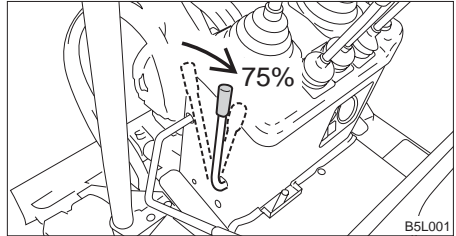

- Run the engine with 75% the maximum speed.

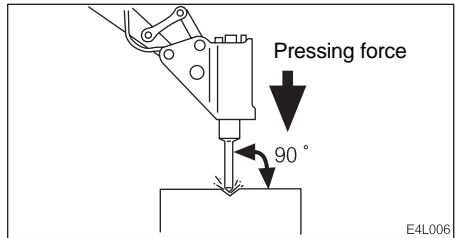

- Pound with the chisel perpendicular to the surface you are pounding.
- When pounding, press the chisel properly against the object to be broken so as to avoid pounding the air.

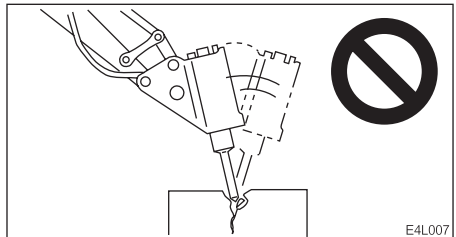

- Do not pry with the chisel, and do not pry while pounding.
- Do not move the chisel while pounding.
- Do not pound continuously for over 30 seconds on the same surface.

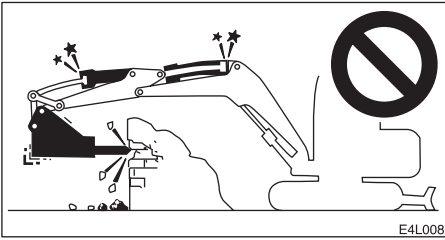

- Do not pound with the cylinder fully extended or contracted (at the stroke end). Leave a margin of at least 5 cm.

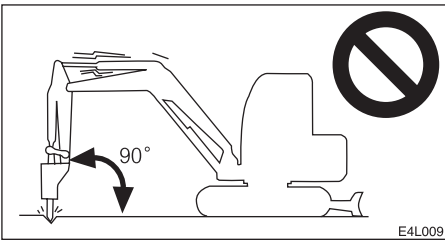

- Do not pound with the arm perpendicular to the ground surface.

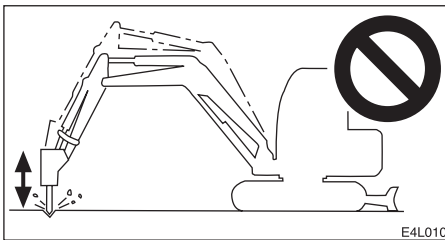

- Do not drop the breaker itself on the object to be broken in order to break it.
- Do not move objects to be broken or rocks with the breaker itself.
- Slew occasionally to cool the engine.
- If a hydraulic hose is vibrating abnormally, nitrogen gas may be leaking from the accumulator. Have an inspection as soon as possible.

Replace the hydraulic oil regularly!

- When using a hydraulic breaker, the oil deteriorates quicker than during normal digging. Be sure to replace the hydraulic oil and return filter element.
- Failure to replace these in time can lead to damage to the machine and breaker's hydraulic systems. In order to improve the service life of the hydraulic systems, be sure to replace the hydraulic oil and return filter element after the number of hours shown on the diagram below.
- Clean the suction strainer when changing the return filter element.

Replacement Interval (Hours)

Item	Hydraulic Oil	Filter Element
1st time	—	25
2nd time	—	100
Periodically	600	200

When the breaker operating ratio is 100%

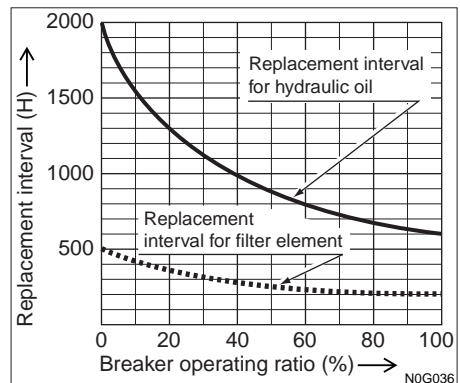

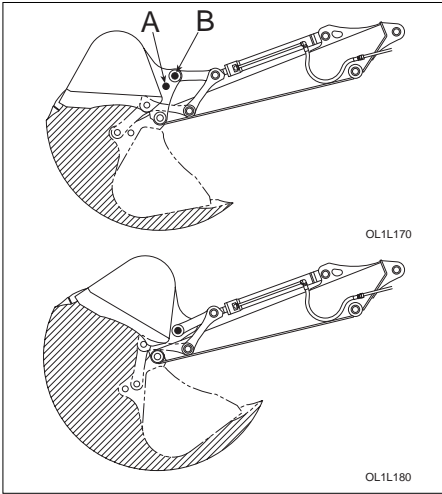

The digging capacity increases when the bucket's link arm installation position is switched from (A) to (B). However, this shortens the bucket stroke.

- Struck capacity (SAE) : 0.017 m³ (0.59 ft³)
- Rated capacity (SAE) : 0.021 m³ (0.73 ft³)

Changing the Link Arm Installation Position

Refer to page 119 "Replacing the Bucket" in the manual.

Replacing the Bucket Teeth

Replace the bucket teeth when the tooth points are worn, before the adapter is damaged.

! WARNING

- **Before performing maintenance or repairs under the machine, set all working equipment against the ground or in the lowermost position.**
- **To prevent unexpected movement, securely block the working elements when repairing or replacing the bucket teeth.**
- **Wear required appropriate equipment such as safety glasses when using hammers, as metal fragments or other objects can fly and cause serious personal injury.**
- **Do not allow unauthorized personnel in the work area.**

Removal

1. Clean the bucket and park the machine in a flat, safe place where the ground is hard.

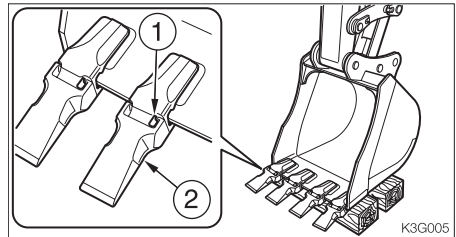

2. Set the bottom surface of the bucket flat and lower it on a block so that the locking pin (1) can be knocked out.



3. Remove the key, then check that the bucket is stable.

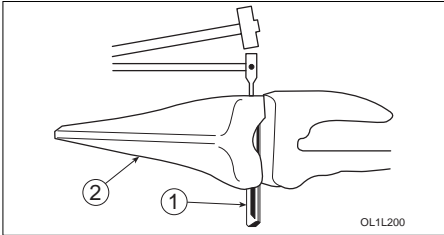

4. Place a rod against the locking pin (1) and knock the locking pin out by hammering against the rod. The rod should be round and thinner than the locking pin.

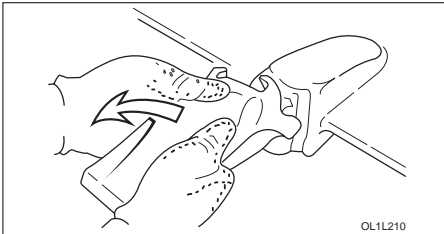

5. Remove the tooth point (2). Some tooth points (2) are of the type that are removed by turning (twisting) them counterclockwise. The same procedure can be used to remove the other tooth points.

Installation

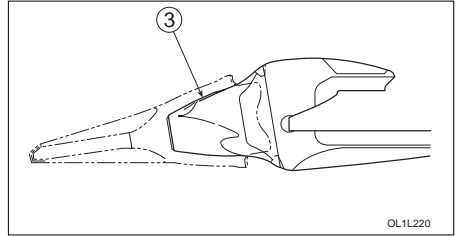

1. Clean the adapter nose (3). If there is gravel or mud on the adapter nose, the tooth point will not go in all the way and the pin cannot be driven in.

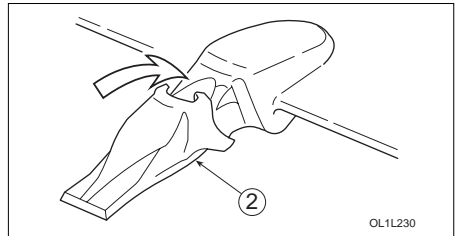

2. Put the tooth point (2) in the adapter nose (3). Push in firmly until the tooth point (2) touches the tip of the adapter nose (3). Some tooth points (2) are of the type that are installed by turning (twisting) them clockwise.

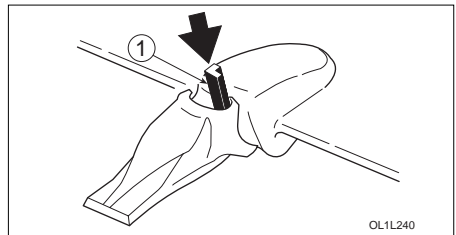

3. Insert the locking pin (1), making sure it is in the right direction.



OPTIONS

3-Holes Bucket

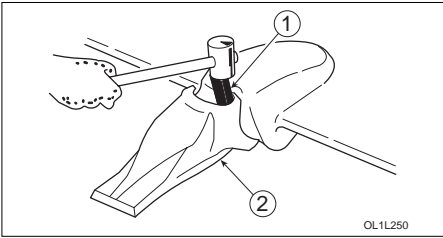

4. Drive in the locking pin (1) with a hammer until it is flush with the tip of the tooth point (2) ear.

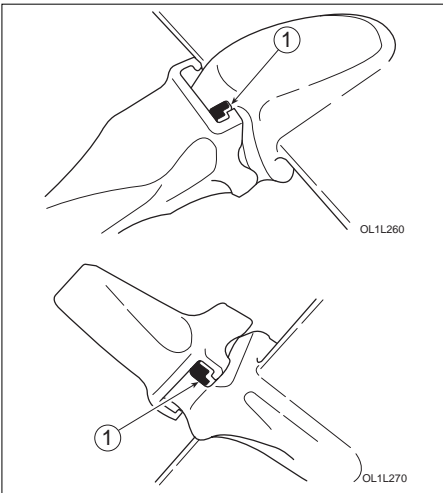

5. The locking pin (1) is now driven in. The same procedure can be used to install the other tooth points.



An alarm is sounded when the machine travels and stops when traveling is stopped. If the alarm does not sound when the machine travels, the fuse may be blown. Inspect the fuse.

⚠ WARNING

If the fuse which has just been replaced should blow again, there is a problem in the electrical system. This could cause fires. Contact a Takeuchi sales or service outlet.

Fuse Layout and Circuits Protected

Capacity	Protected circuit
10A	Horn
10A	Water temperature gauge
10A	Boom light, Travel alarm
30A	Stop solenoid

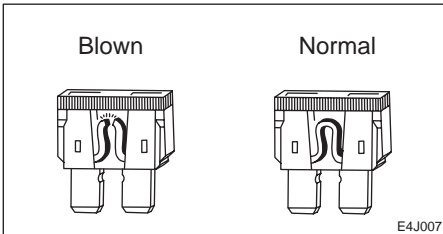
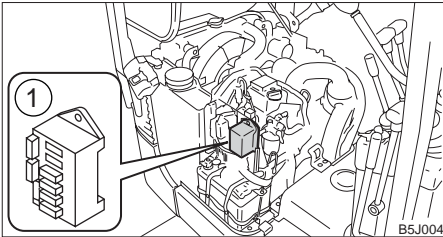

1. Park the machine in a safe place.
2. Set the starter switch to OFF.
3. Open the fuse holder and inspect for blown fuses.
4. If a fuse is blown, replace it with a spare fuse of the same capacity.



Biodegradable oil

Biodegradable oil is a new type of hydraulic oil that is decomposed into carbon dioxide and water by microorganisms in the soil and water. It is highly safe for living organisms and offers advantages in terms of environmental protection.

- Recommended biodegradable oil: Mobile EAL Envirosyn 46H (an ester synthetic oil).
When replacing the hydraulic oil with biodegradable oil, use the above or an equivalent oil. Note that other oils, even other brands of ester synthetic oils, may damage O-rings, packings and seals. Takeuchi products shipped with the optional biodegradable oil are shipped with the above brand of oil.
- When switching from a mineral oil to a biodegradable oil, the parking brake torque decreases by about 30%.

Replacing the hydraulic oil with biodegradable oil

Mixing mineral oil with biodegradable oil will result in a decrease of the hydraulic oil's performance as well as a decrease in biodegradability and safety. The hydraulic oil system must be flushed as described below before supplying the biodegradable oil. This operation is dangerous and requires experience. Have it performed by a Takeuchi sales or service outlet.

Flushing

- To be performed by a Takeuchi sales or service outlet
1. Drain the hydraulic oil (mineral oil) from the hydraulic tank and clean the inside of the tank and suction strainer.
Refer to page 117 "Replacing the Hydraulic Oil and Cleaning the Suction Strainer".
 2. Remove the cylinder hoses and drain the hydraulic oil (mineral oil) from inside the cylinders.
 3. Supply new biodegradable oil to the hydraulic tank.
 4. Bleed the air from the pump and cylinders and pressurize the hydraulic tank.
 5. Operate the hydraulic devices for 30 minutes.
 6. Drain the biodegradable oil from the tank and cylinders.
 7. Replace the hydraulic oil return filter with a new filter.
 8. Repeat steps 3 and 4.
 9. Operate the hydraulic devices for 30 minutes.
 10. Drain the biodegradable oil from the tank and cylinders.
 11. Repeat steps 3 and 4.
 12. Operate the hydraulic devices for 1 hour.
 13. Drain the biodegradable oil from the tank and cylinders.
 14. Replace the return filter with a new filter.
 15. Repeat steps 3 and 4.
 16. Operate the hydraulic devices, then check for oil leakage.
- There is no need to flush the hydraulic oil system when switching from biodegradable to mineral hydraulic oil.

**⚠ CAUTION**

Always fasten the seat belt securely before starting the engine.

Fastening the seat belt

1. Adjust the seat to the optimum position for operating, raise your torso, and sit back firmly into the seat.

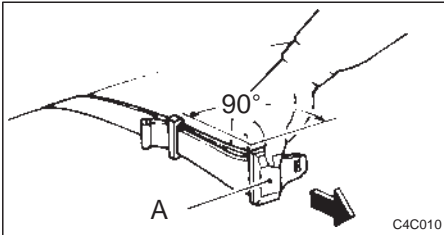

2. Pull on adjuster (A) in the manner shown in the diagram to adjust the seat belt to the desired length.

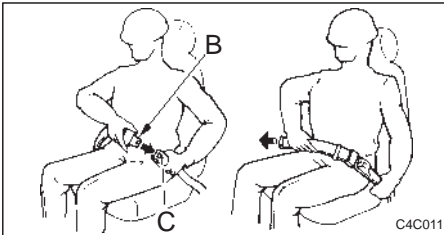

3. Make sure that the belt is not twisted and then insert the tongue plate (B) into the buckle (C) of the seat belt until you hear a clicking sound as it locks in place.
4. Pull the belt until you can feel the pressure on your pelvis with the belt firmly in place.

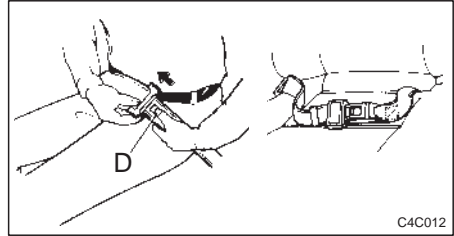
Releasing the seat belt

1. To remove the seat belt, simply press the button (D) located on the buckle. Once the belt has been removed, reinsert the tongue plate into the buckle so that seat belt remains in full view.



INDEX

**A**

Accessories	47
After Cold Weather is Over	76
After First 250 Hours (New Machines Only)	110
After First 50 Hours (New Machines Only)	102
After starting the engine	15
After the Fuel Runs Out	129
Always keep the machine clean	12
Always clean the machine	26
Anti-explosive lighting	25
Attach a "DO NOT OPERATE" tag	25
Auxiliary Hydraulic Lines	47
Auxiliary Pedal	45
Avoid battery hazards	30
Avoid fire and explosion hazards	10

B

Be careful not to get crushed or cut	11
Be careful with fluids under pressure	29
Be careful with grease under pressure	29
Be careful with hot and pressurized components	28
Be careful with hot cooling systems	28
Be sure to lock the safety lock lever before leaving the operator's seat	10
Before Starting Operation	52
Before Starting the Engine	53
Biodegradable Oil	159
Blade Lever	44
Bleeding the Air from the Fuel System	129
Boom Light	42
Boom Swing Pedal	45

C

Canopy (When equipped with Lift eyes)	152
---	-----

Cautions	78
Cautions after Completing Operations	76
Cautions on Maintenance	86
Cautions on opening the engine hood	27
Cautions on Operating	69
Cautions on Towing	22
Cautions on Transporting	84
Cautions on traveling on slopes	18
Cautions on Traveling on Slopes	70
Changing the Crawler Width	60
Changing the Dozer blade width	61
Changing the Link Arm Installation Position	155
Check for safety in the surrounding area before starting	16
Check the position of the under-carriage (tracks) before traveling	17
Checking the fuel level	99
Checks after maintenance	31
Cleaning the air cleaner	111
Cleaning the engine cooling system	114
Cleaning the fuel filter	109
Cleaning the radiator fins	112
Cleaning the water separator	109
Clear the area of other persons before starting the machine	14
Controls	35

D

Daily Inspection	52
Daily Inspection (Every 10 Hours)	97
Danger of flying objects	22
Disconnect the battery	30
Disposing of wastes	31
Do not allow unauthorized personnel in the work area	25
Do not permit riders on the machine	16
Doors and Covers	38



Draining the fuel tank 108

E

Engine Hood 38

Ensure good visibility 16

Every 100 Hours 109

Every 1000 Hours 114

Every 2000 Hours 117

Every 250 Hours 111

Every 50 Hours 105

Every 500 Hours 113

Excavators are not designed for lifting loads 21

Exhaust fumes from the engine can kill 11

Expendables 89

External Power Socket (for EU) 48

F

Fuel and Lubricant Chart 88

Fuel Filler Cap 39

Fully extend the crawler width when operating 17

G

General 86

General precautions 8

General Precautions 150

Getting Out of Mud 72

H

Handling asbestos dust 11

Handling in Cold Weather 76

Handling of hoses 28

Handling Rubber Crawlers 77

Have a Takeuchi service agent repair welding cracks
or other damage 31

Horn Switch 42

Hydraulic Breaker 153

I

If a Fuse Blows 130

If a Warning Lamp is illuminated 131

If the Battery Goes Dead 128

If the Engine Overheats 127

Important Parts 92

In cold weather 15

Index 161

Inspecting and adjusting the crawler tension 105

Inspecting and adjusting the engine valve clearance ... 116

Inspecting and adjusting the fan belt 104

Inspecting and adjusting the fan belt 112

Inspecting and Replacing the Fuse 130

Inspecting and replenishing the coolant 97

Inspecting and replenishing the engine oil 98

Inspecting by opening the engine hood 95

Inspecting by walking around the machine 96

Inspecting the battery fluid level and replenishing ... 107

Inspecting the engine fuel injection pressure
and spray condition 116

Inspecting the engine fuel injection timing 118

Inspecting the engine fuel injection valve 118

Inspecting the Fusible Link 130

Inspecting the hydraulic oil level and replenishing ... 100

Inspecting the rubber crawlers 121

Inspecting the water separator 99

Inspecting while sitting in the operator's seat 96

Inspection After Warm-up 59

Inspection and Checks After Stopping the Engine 75

Instruments 41

Insure driver safety before loading trucks 19



Introduction	2
--------------------	---

K

Keep a safe distance from electrical power lines	19
Know the working area	12

L

Lever Pattern (ISO Pattern)	56
Lever Pattern (JCB Pattern)	57
Levers and Pedals	43
Lifting Capacities	143
Lifting the machine safely	24
Load and unload the machine safely	24
Loading and Unloading	82
Long-term Storage	124
Lubricating the slew bearing	106
Lubricating the slew motor pinion	107
Lubricating the working equipment	101

M

Machine Description	3
Machine Dimensions	138
Machine Operation	56
Main Specifications	137
Maintain three point contact when mounting and dismounting	14
Maintenance	85
Maintenance Chart	93
Maintenance Description	86
Maintenance precautions	25
Manual Case (option)	39
Meters	41
Mounting and Dismounting	52

N

Names of Components	36
Never modify the machine	11
Never remove safety equipment	9
Never slew (swing) sideways with excessive weights	21

O

Observe all safety rules	8
Operate on snow or ice with extra care	18
Operating Levers	44
Operating on slopes is dangerous	20
Operating precautions	16
Operating Procedures	67
Operating Range	140
Operating the Auxiliary Hydraulics	66
Operating the Travel Levers	61
Operating the Working Equipment	64
Operation	51
Operations Possible with this Machine	73
Options	149
Other Symptoms	132

P

Park safely	23
Parking	75
Parking the Machine	75
Pedal Stopper	46
Perform inspection and maintenance daily	13
Place heavy objects in a stable position	27
Precautions on Installing Attachments	150
Precautions on Operating	153
Precautions on Operating Attachments	151
Precautions on Safety	150
Prepare the work area	26



Preparing for Cold Weather	76
Preparing precautions	12
Prohibited Actions	77
Prohibited Operations	67
Provide a fire extinguisher and first aid kit	9

R

Release all pressure before working on the hydraulic system	29
Replace important safety parts periodically	25
Replace the hydraulic oil regularly!	89
Replace the hydraulic oil regularly!	154
Replacing the air cleaner element	115
Replacing the bucket	119
Replacing the Bucket Teeth	155
Replacing the engine oil and oil filter	103
Replacing the engine oil and oil filter	112
Replacing the fuel filter	113
Replacing the hydraulic oil and cleaning the suction strainer	117
Replacing the hydraulic oil return filter	102
Replacing the hydraulic oil return filter	113
Replacing the hydraulic oil with biodegradable oil ...	159
Replacing the rubber crawlers	122
Replacing the travel motor gear oil	110
Replacing the travel motor gear oil	116
Retightening the engine cylinder head bolts	116

S

Safety	7
Safety Lock Lever	43
Safety signs (decals)	32
Seat	40
Seat and Seat Belt	40

Seat Belt	160
Securely block the machine or any component that may fall	27
Securely block the working equipment	27
Securing the Machine	83
Selector Lever	46
Service Data	88
Slew Lock Lever	43
Specifications	135
Start the engine from the operator's seat	14
Starter Key	38
Starter Switch	42
Starting and Stopping the Engine	53
Starting precautions	14
Starting the Engine	54
Starting with jumper cables	15
Stay clear of moving parts	26
Stop the engine before performing maintenance	26
Stopping precautions	23
Stopping the Engine	55
Switches	42
Switching the Lever Pattern	49
Symptoms that are not Malfunctions	126

T

3-Hole Bucket	155
Throttle Lever	44
Tightening Torques	91
Tools	90
Towing	134
Transport	81
Transport the machine safely	24
Transporting precautions	24
Travel Alarm	158
Travel Levers	44
Travel safety	17



Travel Speed Lever 45
Troubleshooting 125

U

Use a signal person and flagman 9
Use caution when fueling 28
Use the correct tools 25
Using optional products 11

W

Walk-Around Inspection 52
Walk-Around Inspection 95
Warming Up the Engine 55
Warming Up the Machine (Hydraulic Oil) 58
Warning Lamps 41
Watch boom clearance 21
Watch out for hazardous working conditions 20
Wear appropriate clothing and personal protective
equipment 8
When Required 119

First Published September 2001
Tenth Published March 2006

No.23105

OPERATOR'S MANUAL

TB108 Compact Excavator

Edited and issued by TAKEUCHI MFG. CO., LTD.

Printed in Japan by STATION M Co., Ltd.

CALIFORNIA

Proposition 65 Warning

Diesel engine exhaust and some of its constituents are known to the State of California to cause cancer, birth defects, and other reproductive harm.

Battery posts, terminals and related accessories contain lead and lead compounds, chemicals known to the State of California to cause cancer and birth defects or other reproductive harm. Wash hands after handling battery.